

electricIQ

**Wall Mountable Compressor
Digital Dehumidifier with Humidistat
CDW12L – 12 litres per day
USER MANUAL**

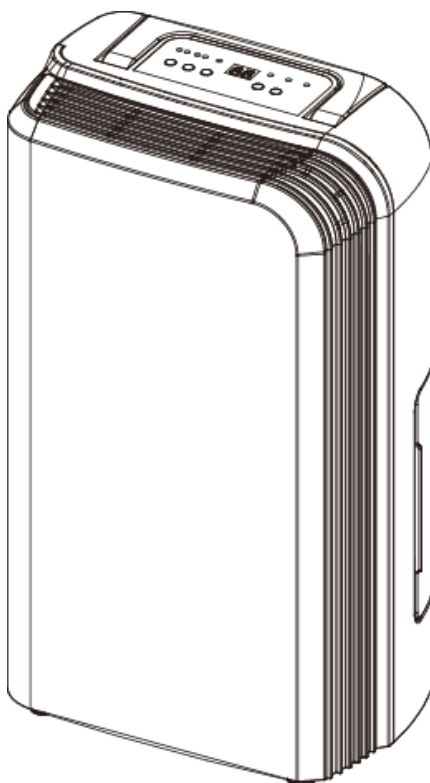

Thank you for choosing ElectricIQ.

**Please read this user manual before using this innovative Dehumidifier
and keep it safe for future reference.**

Visit our page www.electriQ.co.uk for our entire range of Intelligent Electricals

Contents

Safety Instructions	1
Installation	2
Parts and Control Panel	3
Quick reference guide	4
Positioning	6
Water Drainage	7
Care and Maintenance	8
Troubleshooting	9
Technical Data	10

SAFETY INSTRUCTIONS

Important

- Carefully read the instructions before operating the unit
- This appliance is for indoor use only.
- Rating: This unit must be only connected to a 220-240 V / 50 Hz earthed outlet.
- Installation must be in accordance with regulations of the country where the unit is used.
- If you are in any doubt about the suitability of your electrical supply have it checked and, if necessary, modified by a qualified electrician.
- This dehumidifier has been tested and is safe to use. However, as with any electrical appliances - use it with care.
- Disconnect the power plug from socket before dismantling, assembling or cleaning.
- Avoid touching any moving parts of the appliance.
- Never insert fingers, pencils or any other objects through the guard
- This appliance is not intended for use by persons (including children) with reduced physical, sensory or mental capabilities. It is also not intended for use by those with a lack of experience and knowledge, unless they have been given supervision or instruction concerning the use of the appliance by a person responsible for their safety.
- Do not leave children unsupervised with this appliance.
- Do not clean the unit by spraying it or immersing it in water.
- Never connect the unit to an electrical outlet using an extension cord. If a power outlet is not available, one should be installed by a qualified electrician.
- Never operate this appliance if the cord, power adapter or plug is damaged. Ensure the power cord is not stretched or exposed to sharp object/edges.
- A damaged power supply cord should be replaced by the manufacturer or a qualified electrician in order to avoid a hazard.
- Any service other than regular cleaning or filter replacement should be performed by an authorized service representative. Failure to comply could result in a voided warranty.
- Do not use the appliance for any other purposes than its intended use.
- Do not tilt the unit while in use. The unit is design to work only in vertical position.
- This dehumidifier must always be stored and transported upright, otherwise irreparable damage may be caused to the compressor; if in doubt we suggest waiting at least 24 hours before starting the unit.
- Avoid restarting the dehumidifier unit unless 5 minutes have passed since being turned off. This prevents damage to the compressor.
- Never use the mains plug as a switch to start and turn off the dehumidifier. Use the provided ON/OFF switch located on the control panel.
- Always place the unit on a dry and stable surface.

- The appliance should not be installed in laundry or wet rooms where the humidity is higher than 85% RH
- Do not dry laundry above the unit to prevent water entering the dehumidifier. Place the laundry at least 1 meter away from your dehumidifier.
- Do not place the unit next to heat sources (e.g. Electrical fires, fireplaces, etc.)

Energy Saving and Unit Safety Protection Tips

- Do not cover or restrict the airflow from the outlet or inlet grills.
- For maximum performance the minimum distance from a wall or objects should be 20 cm
- Keep the filters or grills of the unit clean. Under normal conditions, filters or grills should only need cleaning once every three weeks (approximately). Since the filters remove airborne particles, more frequent cleaning maybe necessary, depending on the air quality. Vacuum and wash the mesh filters with hot soapy water and dry them before placing them back in the unit

Installation

Remove any water from the water tank before starting the unit. In order to save energy, do not open windows or doors while the unit is running. Place the unit on a hard / flat surface. On first use run the unit continuously for 24 hrs.

To reduce noise levels:

Place a piece of carpet or a rubber mat under the unit to reduce any vibrations while the unit is running.

CDW12L dehumidifier uses compressor technology to extract water from the environment. The compressor dehumidifiers are ideal for normal domestic or office environment which heated during the winter months with temperatures above 12-15°C.

CDW12L is easy to move around on castors and is an intelligent dehumidifier which will extract unwanted humidity while saving money due to their humidistat and power saving logic. CDW12L features an intelligent humidistat which is adjustable in increments of 5% from 35-80% RH insuring your room is not dried too much and power is not wasted.

PARTS

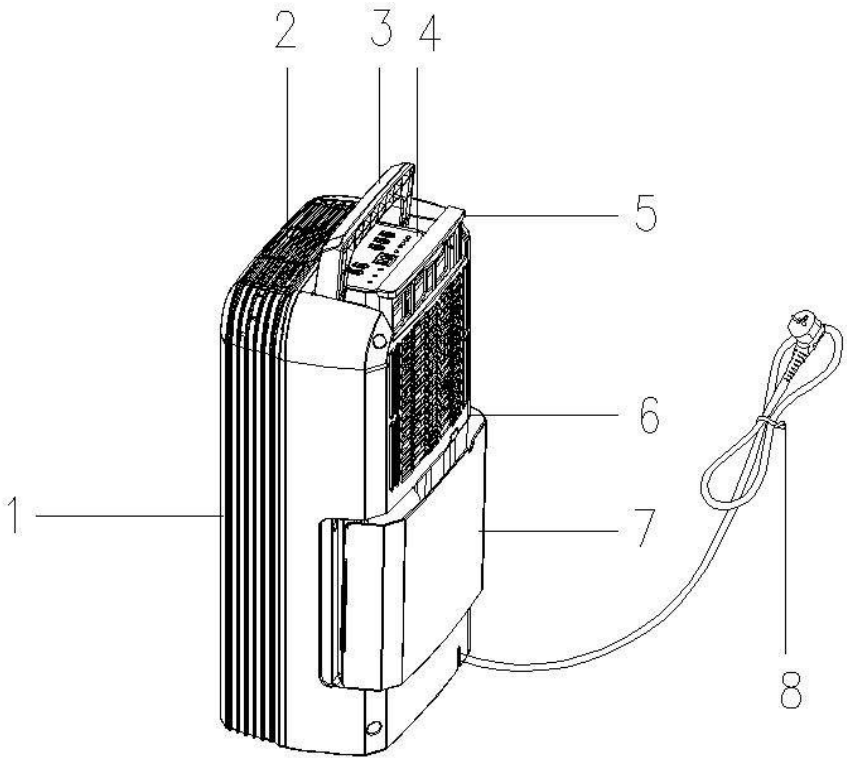

- 1. Front panel
- 4. Control Panel
- 7. Water tank

- 2. Dry Air Outlet
- 5. Mesh Filter
- 8. Supply cord

- 3. Carrying Handle
- 6. Air Intake

OPTIONAL

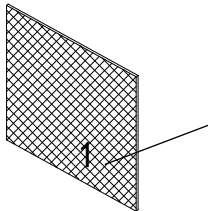

1. Activated carbon filter (Optional)

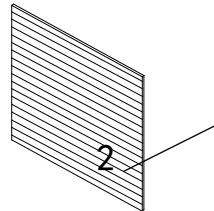

2. PU filter (Optional)

CONTROL PANEL

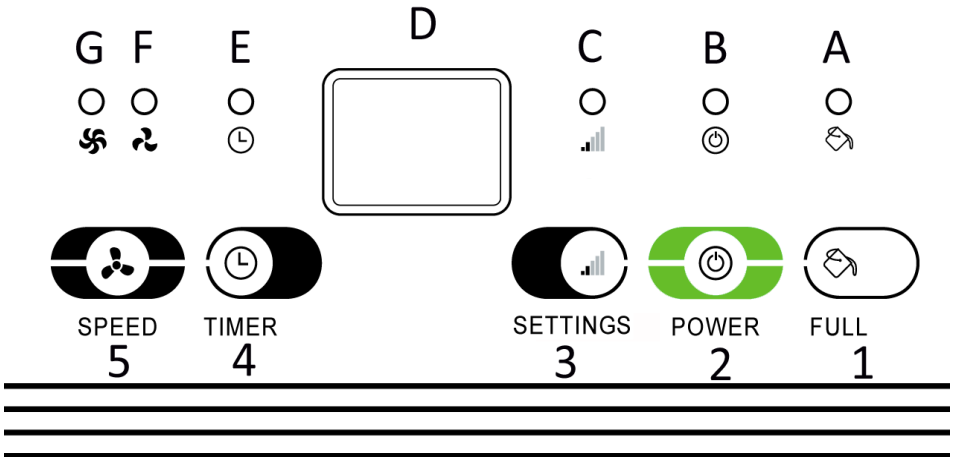

LED INDICATORS

- (A) Tank full indicator light (red)
- (B) Power ON indicator light (green)
- (C) Settings light (green)
- (D) Humidity Level and Timer 2 digit led display
- (E) Timer indicator light (green)
- (F) Low fan speed light (green)
- (G) High speed fan light (green)

- (1) Tank full
- (2) **Power On / Off** Key
- (3) **Humidity** Control Keys (40-80% RH, incremental with 5%)
- (4) **Timer** settings (1-24 hrs, start/ stopping timer)
- (5) **Fan Speed** settings Key (Low/High)



Humidity Level & Timer 2 digit display



The led indicator performs the following functions:

1. When the unit is plugged in, it will indicate the room humidity level
2. When the humidity level is selected, it will indicate the set humidity
3. When the start / stop timer is programmed will show the set timer

Notes:

When humidity level is outside the normal operational parameters will show LO/HI
 If ambient humidity is lower than 35%, it will show "LO"
 If ambient humidity is higher than 95%, it will show "HI"

Quick Reference Guide

Power Key (2) Press to turn the dehumidifier on and off.

Humidity Settings Keys (3) humidity level can be set within a range of 40% RH (Relative Humidity) to 80% RH in 5% increments. Ideal setting is 50-55%. For drier air/ laundry mode press  the key and set to a lower percent value (e.g. 40-45%).

For allowing more moisture in the air, press the humidity control key and  set to a higher percent value (e.g. 60-65%).

The humidity control key will cycle from 40-80%RH and back to 40%RH

Continuous/ Laundry Mode for the dehumidifier to operate continuously for maximum water extraction until the tank is full set the humidity level to 40%RH. 40% is very dry and the unit will work until water tank is full as 40%RH is hardly achievable in UK domestic environment.

Timer (4) settings  (1-24 hrs, start/ stopping timer). In power on mode the set number will represent the number of hours the unit will stop. This will remain unaffected if unit goes in defrost mode or tank is emptied than reinserted. In standby mode the set number represent period in hours after the unit will start. To cancel start / stop mode set the timer to 00.

Other features and Indicators

Tank Full Light

Red light will be on and the unit will beep when the tank is ready to be emptied, or when the tank is removed or not replaced in the proper position. The water level control switch shuts off the dehumidifier when the tank is full, or when the tank is removed or not replaced in the proper position. Empty to resume operation.

Auto Defrost

When frost builds up on the evaporator coils, the compressor will cycle off and the unit will go in defrost mode

When the unit is running in a room with temperature between 5°C and 12°C, it enter the defrost mode about once every 30 minutes.

When the unit is running in a room with temperature between 12°C and 20°C, it enter the defrost mode about once every 45 minutes.

Normal operation will resume after defrost mode.

Humidistat control and fan/ compressor operation

When the selected humidity is lower by 2% than the user selected humidistat setting; the dehumidifier's compressor will be shut off automatically but the fan will still move for few more minutes to ensure air is not stale in the room. The unit will use only a minimal amount of energy in fan mode.

When the humidity is going back to being equal or higher than user selected humidity the compressor will restart once the 3 minutes delay compressor protection expires.

Auto-Restart (on some models)

If the unit stops off unexpectedly due to the power cut, it will restart with the previous function selected automatically when the power resumes.

Power

After the unit has stopped, it is not recommended to resume operation in the first at least 10 minutes. This is to protect the compressor. Operation can resume after this period lapse. When the unit is restarted there is a 3 minutes delay before compressor will start.

Lightweight Portable Design with wall mountable cap

The dehumidifier is built to be compact and lightweight. The casters on the bottom of the unit make it easy to move from room to room. You can remove the castors if you wall mount the unit (with the optional wall brackets).

Your CDW12L dehumidifiers are advanced micro-CPU controlled devices able of self-diagnostics. The LCD display may also show the error and protections codes.

Positioning the dehumidifier

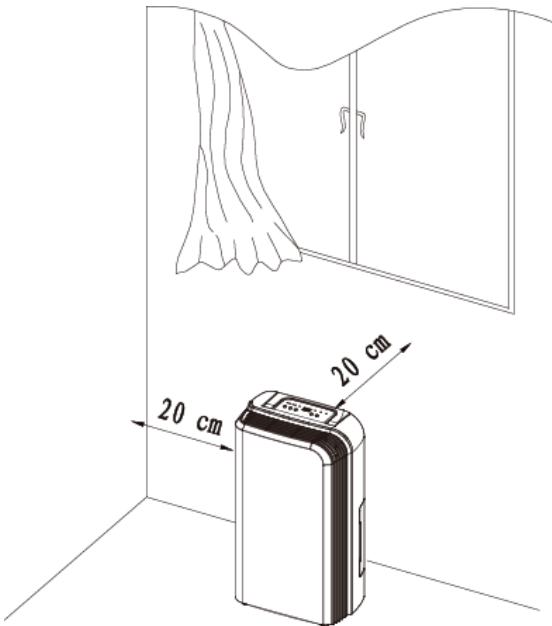

A badly positioned dehumidifier will have little effect in effectively drying the place. In positioning the dehumidifier please ensure circulation of air in not restricted around the unit. Please observe figure on the left in installing the unit.

Allow at least 20 cm space around the unit.

If you wall mount the unit only use brackets provided by the manufacturer as they were specially designed for the unit and to improve the air flow.

This dehumidifier is designed only for indoor residential / office applications and any commercial or industrial use will invalidate the warranty. Place the unit on a flat dry surface or wall mount with the optional brackets. The dehumidifier must be operated in an enclosed area to be most effective. Close all doors, windows to create the best operating environment. Do not use outdoors.

Note: Castors can only move laterally. Do not force castors to move over carpet, nor move the unit with water in the tank as it may tip over and spill water.

Water Drainage

When the water tank is full, the unit will stop automatically. When this happens the **tank full** red code will show on the control panel.

Note: Only empty the water tank when it is full or before moving or storing the unit. There are two ways to dispense collected water.

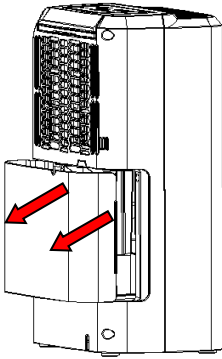

1. Use the tank.

When the tank is full, the unit will automatically stop running, and the Full indicator light will flash.

Slowly pull out the tank. Grip the left and right handles securely, and carefully pull out straight so water does not spill. Do not rest the tank on the floor because the bottom of the tank is uneven and tank will fall and cause the water to spill. Empty the water tank and reinsert it into the dehumidifier. The tank must be in place and securely seated for the dehumidifier to operate again.

The dehumidifier will re-start when the tank is restored in its correct position.

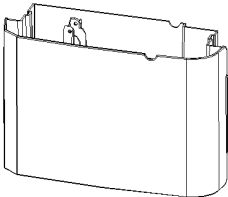
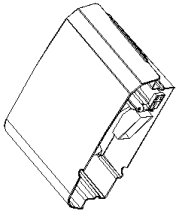

NOTES:

When you remove the bucket, do not touch sensors or any parts which are situated behind tank. Doing so may damage the product. Be sure to push the tank gently all the way into the unit. Banging the bucket against anything or failing to push it in securely into place may cause the unit not to operate.

Do not remove the float from the water tank. The water full sensor will no longer be able to detect the water level correctly without the float and water may leak from the water tank.

2. Continuous draining

Water can be automatically plumbed in or drained into sink, a larger recipient or through the wall into an outside drain by attaching a pipe to the unit (10 mm internal diameter) (not included). Insert the pipe into the drain outlet at the back of the unit as shown in here. Make sure the connection between pipe and the drain outlet is tight and does not leak. Then direct the pipe to a suitable drainage point. This unit uses gravity fall to dispose water hence the drain should be lower than the unit water outlet. Put the tank back. Be sure to run the water pipe downward and let the water to flow out smoothly. Do not kink or bend the pipe. **NOTE: When the continuous drain feature is not being used, remove the drain hose from the outlet.**

The permanent drain can be used in conjunction with water pump (e.g. when draining a cellar) to lift the water upwards.

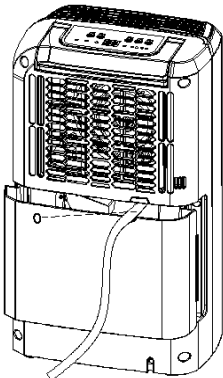

Care and Maintenance

Always shut off the unit and unplug from the mains before cleaning or performing any maintenance. When it is not in use for long periods it is advisable to remove the plug from the power socket. Do not use chemical solvents (such as benzene, alcohol or gasoline) as they may cause irreversible damage to the unit.

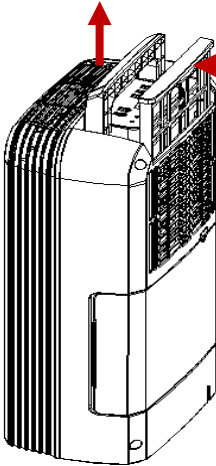

1. Clean the Grille and Case

Use water and a mild detergent. Do not use bleach or abrasives. Do not splash water directly onto the main unit. Doing so may cause an electrical shock and can lead to the insulation to deteriorate, or cause the unit to rust. The air intake and outlet grilles get soiled easily, so use a vacuum attachment or soft brush to clean. If the mesh filter is dirty Hoover it, if it is heavily soiled wash it with warm soapy water and dry thoroughly before reinserting it in the unit.

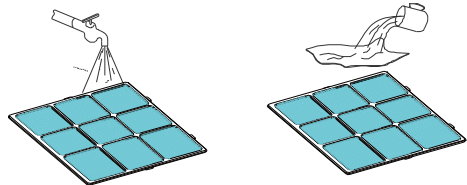

2. Clean the water tank

Every few weeks, clean the tank to prevent growth of mould, mildew and bacteria. Partially fill the tank with clean water and add a little mild detergent. Swish it around in than empty the tank and rinse.

NOTE: Do not use a dishwasher to clean the tank. After cleaning and drying the tank must be reinserted securely into dehumidifier in order to restart operation

Frequently Asked Questions

Why doesn't the dehumidifier seem to extract much water if the temperature is low?

This is a compressor dehumidifier which works best in temperatures above 15°C. If the temperature is low and the air is dryer than the setting on the humidistat the unit will not extract water. If you want to use a dehumidifier for outside buildings, unheated properties, boats or garages please check our desiccant range.

Why doesn't the unit work /or stops suddenly?

The water tank may be full or displaced. To rectify: empty the tank and carefully place the tank back in the unit.

Also the unit may be running in dehumidifying mode with a low room temperature. Please check if the room temperature is lower than 5°C. If so, the unit will stop working while in dehumidifying mode. (unit may be defrosting).

The ambient operating range is between 5°C and 35°C with a relative humidity ranging from 30% to 80%. For maximum efficiency use the unit between 15°C and 32°C.

Sometimes cold and/or hot air comes out from the air outlet grill, why?

When the unit is in dehumidifying mode it absorbs humid air from room and freezes it to reduce the humidity.

During the cold cycle there should be cold air coming out of the unit

During the hot cycle hot dry air should be coming out of the outlet grill.

Troubleshooting

Issue	Cause	Solution
Hot or cold air being produced	Normal Operation	When the unit is in dehumidifying mode it absorbs humid air from room and freezes it to reduce the humidity. During the cold cycle there should be cold air coming out of the unit During the defrost cycle hot dry air should be coming out of the outlet grill.
Unit does not operate	Is the plug properly inserted in the socket?	Insert the plug into the socket and turn the switch on.
	Does the tank full indicator is red?	Tank full, float displaced or tank not properly inserted. Empty tank, check float and make sure tank is properly inserted in unit.
Dehumidifier does not extract water	Is the unit set to a humidity level lower than the one in the room?	Set the humidity level on the humidistat below current humidity reading.
	Is the temperature too low for water extraction to be efficient?	Increase temperature in the room or reposition the unit.
	Is any intake grill or discharge blocked? Is the unit too close to walls.	Remove obstructions and restart the unit. Ensure a distance of at least 20 [cm between the unit & walls
Airflow seems weak	Is filter dirty or clogged?	Please service the filters regularly as per user manual.
Unit is noisy during operation	Is the unit on uneven surface?	Please place on flat horizontal surface.
	Is filter clogged?	Please service the filters regularly as per user manual.
E1 on	Humidity sensor error	Unplug the unit and plug it back in. If error repeats, call for service centre.
E2 on LCD	Temperature sensor error	Unplug the unit and plug it back in. If error repeats, call for service centre.

Unit stops regularly	Unit is defrosting	Allow the unit to automatically defrost. The protect will clear after the unit self defrosts. Increase temperature in the room if this repeats too often
Tank full red light	Water tank full notification	Tank is full or is not in the right position-- Empty the tank and replace in the right position.
Any other malfunctions will need to be reported to ElectriQ service centre. Do not attempt unauthorised repairs as these may invalidate the warranty.		

Technical data

Model	CDW12L Wall mountable
Voltage	1Ph, 220-240V ~, 50Hz
Dehumidifying capacity	12 L / day (at 30° C / 80%RH)
Rated Power	240 W, 1.5 Amp
Starting current	7 Amp
Tank Capacity	1.5 litres
Humidity settings range	40%~80%
Refrigerant	R134, 100 grams
Airflow m3/h	140
Noise level dB(A)	48
Net Dimensions mm (WxDxH)	280x190x470
Gross Dimensions mm (WxDxH)	320x217x535
Net/Gross weight kgs	10/11
All information provided is for reference only. Products specifications may change due to continuous product development.	

Accessories:

Wall mounted brackets can be purchased if the application requires wall mounting. Full install method is provided with the brackets. If continuous drainage option is used in wall mounting mode drain at the front or gently curve the pipe below the unit.

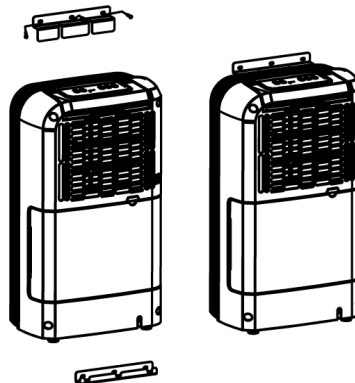

Disposal: Do not dispose this product as unsorted waste. Collection of such waste must be handled separately as special treatment is necessary.

Recycling facilities are now available for all customers at which you can deposit your old electrical products. Customers will be able to take any old electrical equipment to participating sites run by their local councils. Please remember that this equipment will be further handled during the recycling process, so please be considerate when depositing your equipment. Please contact the local council for details of your local household waste recycling centres.



ElectriQ UK SUPPORT

www.ElectriQ.co.uk/support

Please, for your own convenience, make these simple checks before calling the service line.

1. Has the unit been standing upright for at least 2 hours?
2. Is the unit plugged into the mains?
3. Is the fuse OK?
4. Switch the unit off and wait three minutes to see if the issue is resolved. Restart the unit.
5. Check if the water tank is full.

If the unit still fails to operate call: 0871 620 1057 or complete the online form

Office hours: 9AM - 5PM Monday to Friday

www.ElectriQ.co.uk

Unit 2, The Nursery

Berristow Lane

South Normanton

Derbyshire, DE55 2FX