

electriciQ

USER MANUAL

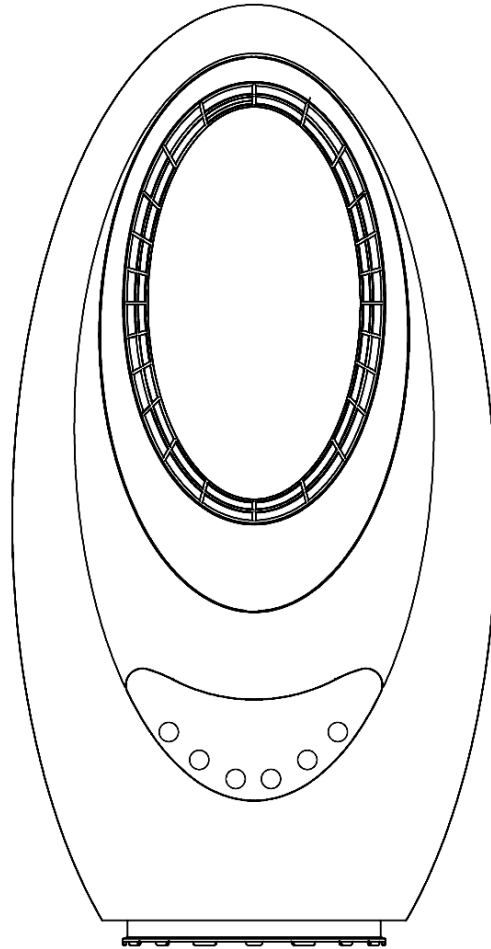

BLADELESS HEATER WITH AMBIENT LIGHT

eiQ-AM09
eiQ-AM09B

White
Black

Thank you for choosing electriciQ
Please read this user manual before using this heater and keep it safe for future reference.

Visit our page www.electriQ.co.uk for our entire range of Intelligent Electricals

THIS PRODUCT IS ONLY SUITABLE FOR WELL INSULATED SPACES OR OCCASIONAL USE

CONTENTS

SAFETY INSTRUCTIONS	3
FEATURES	5
DIAGRAM	5
OPERATION	6
CONTROL PANEL AND SETTINGS	6
REMOTE CONTROL	7
MAINTENANCE	8
TROUBLE SHOOTING	8
TECHNICAL DATA	9
SUPPORT	9
PRODUCT FICHE	10

SAFETY INSTRUCTIONS

Important!

- Carefully read the instructions before operating the unit
- This appliance is for indoor use only.
- Rating: This unit must be only connected to a 220-240 V / 50 Hz earthed outlet.
- Installation must be in accordance with regulations of the country where the unit is used.
- If you are in any doubt about the suitability of your electrical supply have it checked and, if necessary, modified by a qualified electrician.
- This heater has been tested and is safe to use. However, as with any electrical appliance - use it with care.
- Disconnect the power from the unit before dismantling, assembling or cleaning.
- Avoid touching any moving parts within the appliance.
- Never insert fingers, pencils or any other objects through the guard
- This appliance can be used by Children aged from 8 years and above and persons with reduced physical, sensory or mental capabilities or lack of experience and knowledge if they have been given supervision or instruction concerning use of the appliance in a safe way and understand the hazards involved. Children shall not play with the appliance. Cleaning and user maintenance shall not be carried out by children.
- Children aged from 3 years and less than 8 years shall only switch on/off the appliance provided that it has been placed or installed in its intended normal operating position and they have been given supervision or instruction concerning use of the appliance in a safe way and understand the hazards involved. Children aged from 3 years and less than 8 years shall not plug in, regulate, or clean the appliance or perform user maintenance
- Children under 3 years should be kept away unless continuously supervised.
- Some parts of this product can become very hot and cause burns. Particular attention has to be given where children and vulnerable people are present.
- Do not clean the unit by spraying it or immersing it in water.
- Never connect the unit to an electrical outlet using an extension cord. If an outlet is not available, one should be installed by a qualified electrician.
- Never operate this appliance if the unit, cord or plug is damaged. Ensure the power cord is not stretched, exposed to sharp object/edges, or routed under the unit.
- Any service other than regular cleaning should be performed by an authorised service representative. Failure to comply could result in a voided warranty.
- Never use the plug as a switch to start and turn off the heater. Use the provided power button located on the control panel.
- Do not use an external timer.
- Do not cover the air inlet or outlet, or place items close to the unit which may restrict airflow, as this may present a fire risk.
- The heater must not be located immediately below a socket outlet.
- Always place the unit on a dry and stable surface. Do not move or tilt the unit
- Avoid keeping the unit in direct sunlight for a long period of time.

- The heater is designed to be used at temperatures above -20°C. If it is exposed to temperatures below this, it must be allowed to warm above this level before operation.
- Do not attempt to repair, disassemble or modify the appliance. This unit contains no user-serviceable parts.
- Always unplug or disconnect the appliance from the mains power supply when not in use, or when moving or cleaning it. Do not pull the cord to unplug the heater.
- Keep the heater clean. Do not allow any object to enter the ventilation or exhaust opening as this may cause electric shock, fire, or damage to the heater.
- Do not use the appliance for anything other than its intended use. It is designed for domestic indoor use only.
- There may be a trace of odour during the first few minutes of initial use, or after a period of storage. This is normal and will quickly disappear.
- This appliance has hot and arching or sparking parts inside. Do not use it in areas where gasoline, paint, or any flammable liquids are used or stored.
- This appliance is not intended for use in bathrooms, laundry areas and similar humid locations. Never locate this appliance where it may fall into a bathtub or otherwise become exposed to water.
- The remote contains a lithium battery, keep out of reach of small children. Seek Medical advice if swallowed.
- To prevent battery leakage: Remove the battery from the remote if exhausted or before long periods of storage.

ENERGY SAVING AND UNIT SAFETY PROTECTION TIPS

- Do not cover or restrict the airflow. Do not use in dusty environment.
- For safety and maximum performance the minimum distance from a wall or objects should be 50cm.

WARNING: To reduce the risk of fire or electrical shock, DO NOT use this appliance with any solid state Speed Control Device or any variable speed controllers.

eiQ-AM09 BLADELESS HEATER

FEATURES

- Slim design takes minimal space
- High Speed Motor with Fan mode and 2 Heat settings
- Swing Function
- 12 hour standby timer.
- Remote Control allowing all functions to be changed.
- Built in ambient light.

DIAGRAM

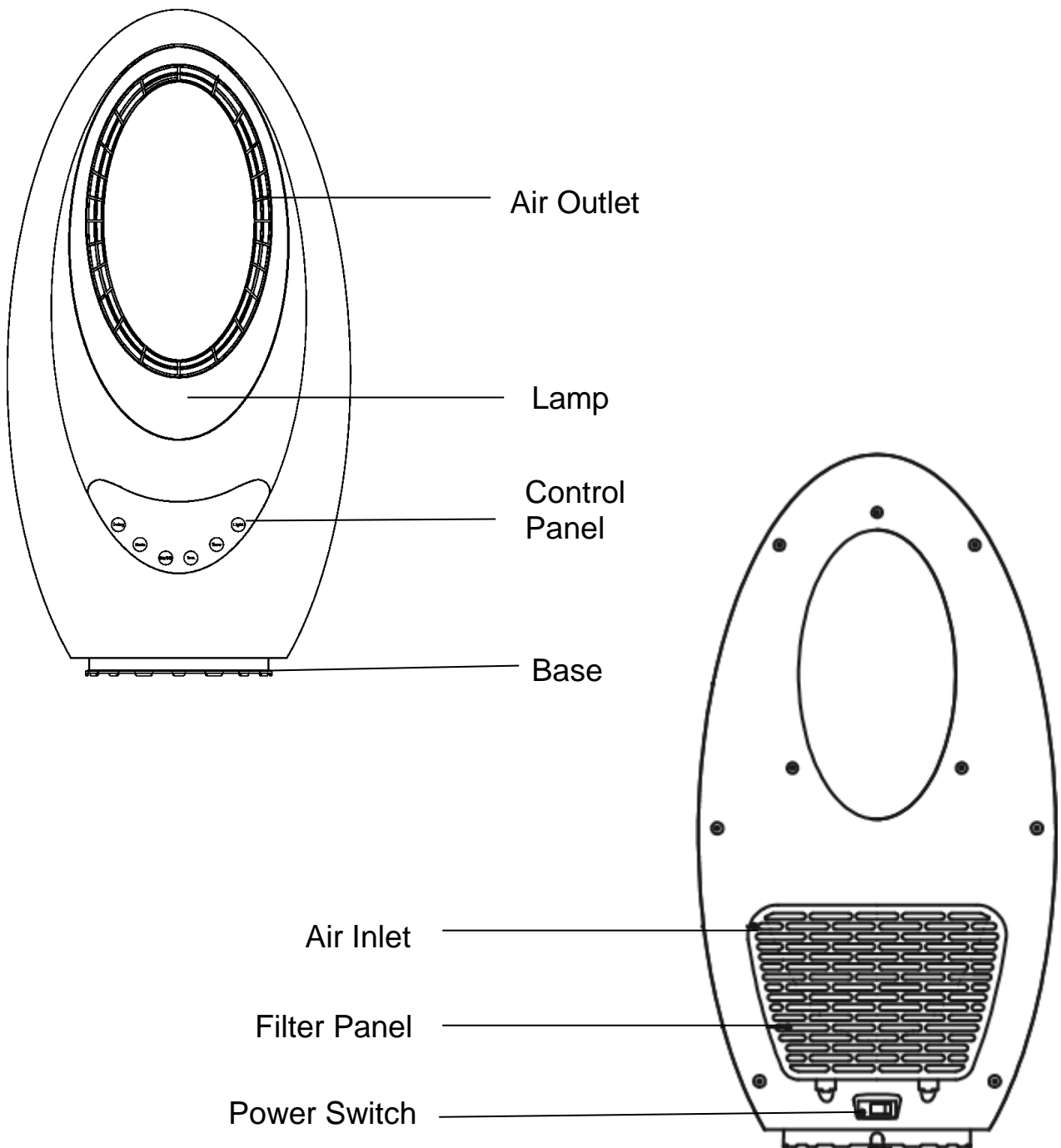

OPERATION

Your heater may be operated by using either the manual controls located on the front of the fan or by your remote control.

POWER SWITCH ON THE BACK OF THE UNIT

Used to turn the bladeless heater ON and OFF. This should be used to turn off the appliance before leaving unattended.

CONTROL PANEL AND SETTINGS

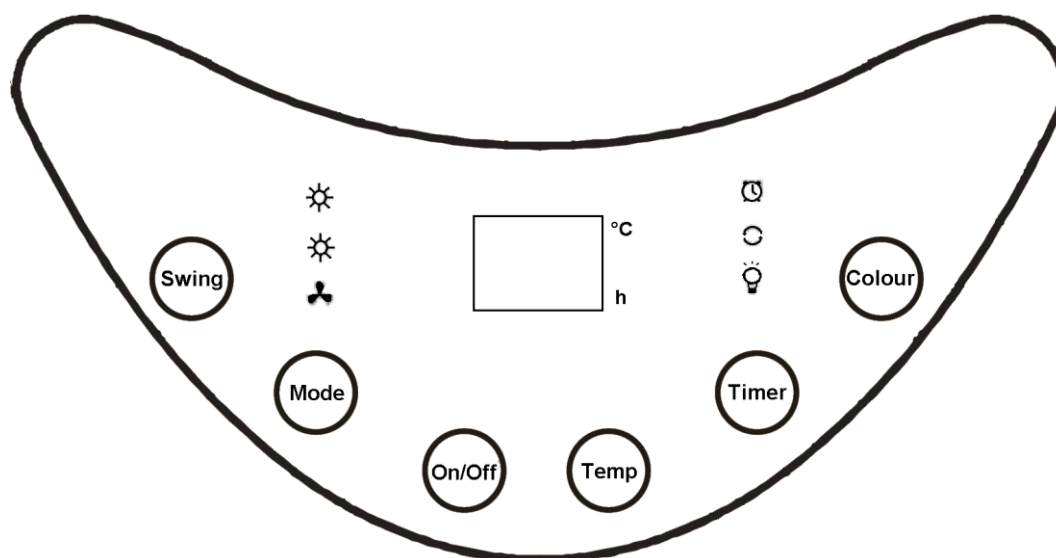



ON/OFF BUTTON

Used to turn the bladeless heater ON and OFF.

SWING BUTTON

Press to turn the Swing function on and off. When it is operational the horizontal direction of the airflow is slowly moved from side to side and the Swing indicator  will be illuminated

MODE BUTTON

Press to cycle through the three available modes: Fan , Low Heating  and High Heating 

TEMP BUTTON

Press repeatedly to increase the desired room temperature. After pressing the temp button the desired temperature will flash for 3 seconds, before the unit reverts to showing the room temperature. When the desired temperature has been reached the unit will change into fan mode. The temperature range is 16°C - 40°C

TIMER BUTTON

Press repeatedly to increase the running time in 1 hour intervals. The timer can be set between 1 hour and 12 hours. The display will show the duration currently set. When the display is showing the timer duration the **h** symbol will illuminate next to the timer. To cancel the timer repeatedly press the timer button until 00 is shown.

COLOUR BUTTON

Press to cycle through the options for the ambient light – Off, White, Green, Purple or Blue. The light can be operated independently to the fan.

REMOTE CONTROL

Your bladeless heater is supplied with a remote, which allows full control of all the unit's functions.

ON/OFF: Turns the fan On and Off

MODE: Cycles between Fan, Low Heat and High Heat.

TIMER: Press repeatedly to set the Off timer in 1 hour intervals. The time set will be displayed on the unit.

SWING: Press to turn the Swing Function On and Off.

LIGHT: Press to change the ambient light between Off, Green, Purple and Blue.

TEM+: Press to increase the desired room temperature.

TEM-: Press to decrease the desired room temperature.

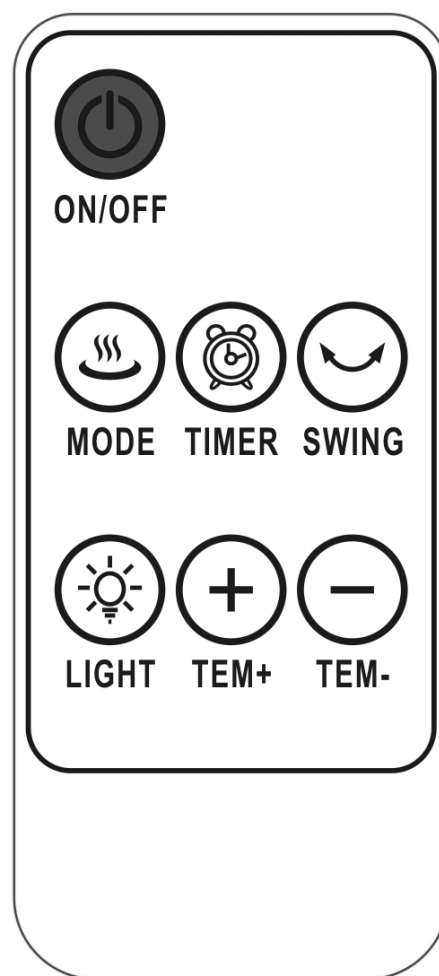

REPLACING THE BATTERIES

The remote control is powered by a Lithium Button Cell Battery (CR2025). Should the remote become unresponsive, replace the battery following the instructions below:

1. Turn over the remote and press tab A to the right.
2. Slide out the battery tray B
3. Replace the battery with the same type, ensuring the positive side is facing upwards.

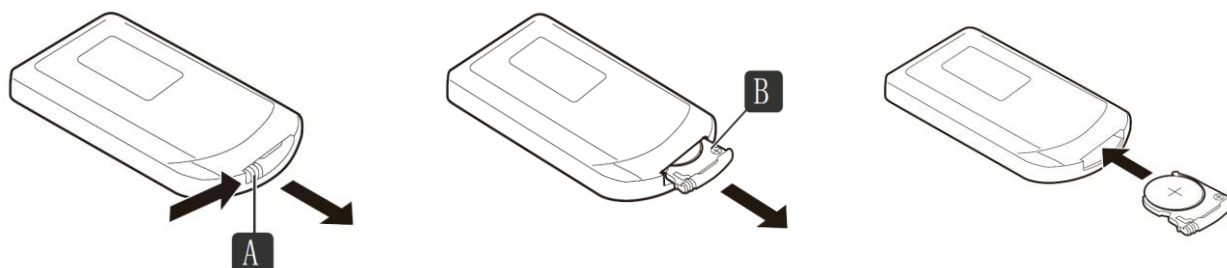

MAINTENANCE

CLEANING AND STORAGE

ATTENTION: Please shut off the unit and unplug from the mains before cleaning or performing any maintenance.

Cleaning the surface

Clean the heater with a duster or a soft wet cloth.

Do not use chemical solvents (such as benzene, alcohol or gasoline) as they may cause irreversible damage. Make sure no water enters the control panel or gaps in the casing.

Do not run the unit until completely dry.

Place the heater in its original box or cover to protect it from dust when not in use.

Store it in a cool dry place.

TROUBLESHOOTING

Do not repair or disassemble the unit by yourself, unauthorized repair attempts will invalidate the warranty and may cause bodily harm.

Issue	Possible Reason	Solution
No power	<ol style="list-style-type: none">1. Power cord is unconnected2. There is no power from socket3. The power switch on the rear of the unit is turned off.	<ol style="list-style-type: none">1. Connect the power cord2. Check socket is turned on3. Ensure the power switch on the rear of the unit is in the On position
Odour emission from unit	<ol style="list-style-type: none">1. New unit. When the unit is used for the first time the fan motor may produce and odour which will dissipate within a week of use	<ol style="list-style-type: none">1. No action required
Strong vibrations and noise	<ol style="list-style-type: none">1. Unit is not places on a flat surface2. Unit may be damaged	<ol style="list-style-type: none">1. Place on a flat surface. May put an anti-vibration mat underneath2. If the heater is damaged discontinue use and contact the service centre.

If the above solutions do not resolve the problem please contact the service centre.

TECHNICAL DATA

Model	eiQ-AM09 / eiQ-AM09B
Cable length	1.5 meters
Rated Input	2 KW
Power Supply	220-240V/50Hz
Net Weight	3.0Kg
Dimensions	570mm x 290mm x 170mm

electriQ UK SUPPORT

www.electriQ.co.uk/support

Please, for your own convenience, make these simple checks before calling the service line.

If the unit still fails to operate call: 0871 620 1057 or complete the online form

1. Is the unit plugged into the mains?
2. Is the fuse OK?
3. Switch the unit off and wait three minutes to see if the issue is resolved. Restart the unit.

Office hours: 9AM - 5PM Monday to Friday

www.electriQ.co.uk
Unit J6, Lowfields Business Park
Lowfields Way, Elland
West Yorkshire, HX5 9DA

APPENDIX

Disposal: Do not dispose this product as unsorted municipal waste. Collection of such waste must be handled separately as special treatment is necessary.



Recycling facilities are now available for all customers at which you can deposit your old electrical products. Customers will be able to take any old electrical equipment to participating civic amenity sites run by their local councils. Please remember that this equipment will be further handled during the recycling process, so please be considerate when depositing your equipment. Please contact the local council for details of your local household waste recycling centres.

PRODUCT FICHE

Model Identifier: eiQ-AM09 / eiQAM09B					
Item	Symbol	Value	Unit	Item	Unit
Heat Output				Type of heat input, for electric storage local space heaters only (select one)	
Nominal heat output	P _{nom}	2.0	kW	manual heat charge control, with integrated thermostat	No
Minimal heat output	P _{min}	1.0	kW	manual heat charge control with room and/or outdoor temperature feedback	No
Maximum continuous heat output	P _{max}	2.0	kW	electronic heat charge control with room and/or outdoor temperature feedback	No
Auxiliary electricity consumption				fan assisted heat output	No
At nominal heat output	e _{lmax}	2.09	kW	Type of heat output/room temperature control (select one)	
At minimum heat output	e _{lmin}	0.89	kW	single stage heat output and no room temperature control	No
In standby mode	e _{lsb}	0.329	W	two or more manual stages, no room temperature control	No
				with mechanical thermostat room temperature control	No
				with electronic room temperature control	Yes
				with electronic room temperature control plus day timer	No
				with electronic room temperature control plus week timer	No
				Other control options (multiple selections possible)	
				room temperature control with presence detection	No
				room temperature control, with open window detection	No
				with distance control option	No
				with adaptive start control	No
				with working time limitation	No
				with black bulb sensor	No
Contact Details	electriQ, Unit J6, Lowfields Business Park, Lowfields Way, Elland, West Yorkshire, HX5 9DA				