

electric*Q*

USER MANUAL



32" FHD LED MONITOR **eiQ-32CVQ165VAFSGH**

Thank you for choosing electricQ

Please read the user manual before using this monitor and keep it safe for future reference Visit www.electriQ.co.uk to view our entire range of Intelligent Electricals

CONTENTS

SAFETY	3
WHATS INCLUDED	5
CONNECTIONS	6
WALL MOUNTING	6
GETTING STARTED	6
SHORT CUT	6
INITIAL SET UP	6
MENU OPTIONS	6
OSD MENU	7
INPUT	8
COLOUR	8
MANUAL IMAGE	9
AUDIO	9
SET UP	10
OTHER	11
TECHNICAL SPECIFICATION	12
TROUBLESHOOTING	13
SUPPORT	13

SAFETY INFORMATION



- Read these instructions - All the safety and operating instructions should be read before this product is operated.
- Keep these instructions - The safety and operating instructions should be retained for future reference.
- Heed all warnings - All warnings on the appliance and in the operating instructions should be adhered to.
- Follow all instructions - All operating and usage instructions should be followed.
- Do not use this equipment near water, or in humid environments - The appliance should not be used near water or moisture e.g. in a wet basement or near a swimming pool.
- Clean only with a dry cloth. Do not use solvents or petroleum-based fluids.
- Do not block any ventilation openings.
- Do not install near any heat sources such as radiators, stoves or other apparatus (including amplifiers) that produce heat.
- Do not tamper with the supplied plug. This plug is a BS1363 standard plug.
- Protect the power cord from being walked on or trapped, particularly at the plug and at the point where it exits from the appliance.
- Only use attachments/accessories specified by the manufacturer.
- Use only with a cart, stand, tripod, bracket or table specified by the manufacturer or sold with the apparatus. When a cart or stand is used, use caution when moving it to avoid any injuries or damage from it tipping over.
- Unplug the apparatus during lightning storms or when unused for long periods of time.
- Refer all servicing to qualified personnel. Servicing is required when the apparatus has been damaged in any way, such as if the power supply cord or plug is damaged, liquid has been spilled or objects have fallen into the apparatus or it has been exposed to rain or moisture, it does not operate normally or has been dropped.
- Please keep the unit in a well-ventilated environment.
- The monitor should only be connected to a mains power supply as rated on the back of the equipment.
- To prevent overload, do not share the same power supply socket with too many other electronic components.
- Do not place any connecting wires where they may be stepped on or tripped over.
- Do not place heavy items on the cable as this may cause damage.
- When removing from a socket hold by the plug and not the wires.
- Disconnect the power immediately and seek professional help if the plug or cable is damaged, liquid has spilt onto the unit, if accidentally exposed to water or moisture, if anything accidentally penetrates the ventilation slots or if the unit does not work normally.
- Do not remove the safety covers. There are no user serviceable parts

inside. Trying to service the unit yourself is dangerous and may invalidate the product's warranty. Only qualified personnel should service this apparatus.

- Do not block ventilation slots on the back cover. The monitor can be placed in a cabinet but ensure at least 5cm (2") clearance all around. Do not tap or shake the screen, this may damage internal components.
- **WARNING:** To reduce the risk of fire or electric shock, do not expose this apparatus to rain or moisture. The apparatus shall not be exposed to dripping or splashing and objects filled with liquids, such as vases, shall not be placed on the apparatus.
- **WARNING:** The wall plug socket is used as a disconnection device and should remain readily accessible.
- **WARNING:** The batteries shall not be exposed to excessive heat such as direct sunlight or fire.
- Although every effort is made to maintain the accuracy of the manual, due to continuous product development, some variation from the manual is possible.
- The availability of features and settings may vary depending on the input source and method of connection.
- Although every effort is made to maintain the accuracy of the manual, due to continuous product development, some variation from the manual is possible.
- The availability of features and settings may vary depending on the input source and method of connection.
- The available resolutions and refresh rates may be limited by the capabilities and/or settings of the source device.



AT FULL VOLUME, PROLONGED LISTENING MAY DAMAGE THE USER'S HEARING.

 <p>This warning sign is to warn of dangerous voltage inside the product.</p>	 <p>CAUTION: To reduce the risk of electric shock, DO NOT remove the cover (or back). No user serviceable parts inside. Refer servicing to qualified service personnel.</p>	 <p>This warning sign is to alert you of important instructions accompanying the product.</p>
--	---	--

WHAT'S INCLUDED

electrico

USER MANUAL



FHD LED MONITOR
#EA-S00131820-4F82H
www.electrico.com.br

USER MANUAL



POWER SUPPLY

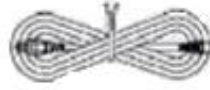

POWER CABLE



HDMI

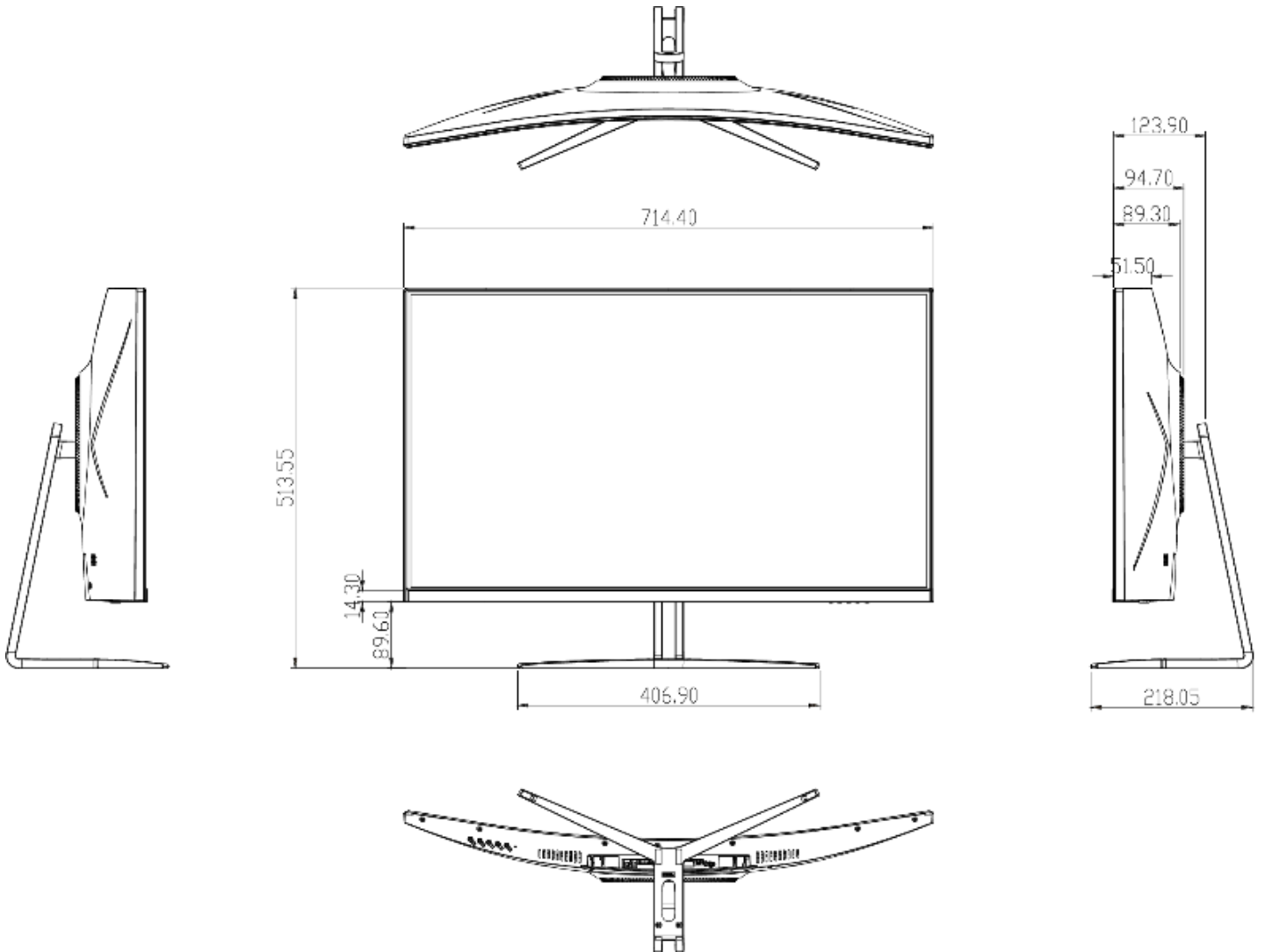

CONNECTIONS AVAILABLE ON THE MONITOR

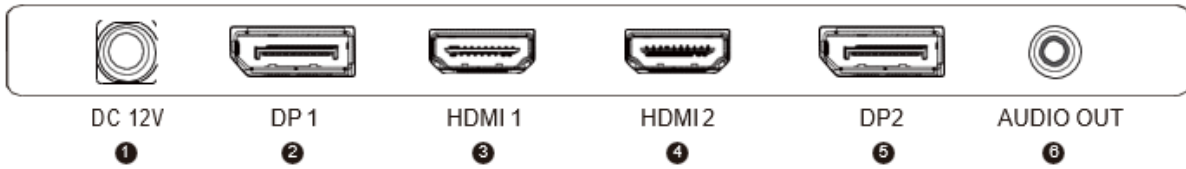

1. POWER
2. DP1 (Display Port 1. 165Hz, Free Sync)
3. HDMI 2.0 (HDMI 2.0, 144Hz, Free Sync)
4. HDMI 1.4 (HDMI 1.4, 75hz, Free Sync)
5. DP2 (Display Port 2. 165Hz, Free Sync)
6. AUDIO OUT

WALL MOUNTING

- The monitor is provided with mounting holes for a VESA approved wall mounting bracket (not supplied).
- The VESA mounting pattern is: 100x100mm and the size of the screws is 4 x M6 x 10 (not supplied)
- Do not use screws longer than specified or damage will occur to the internal components.

NOTE: As the monitor is considered heavy, please consult with a professional wall mount installer to perform the installation.

GETTING STARTED

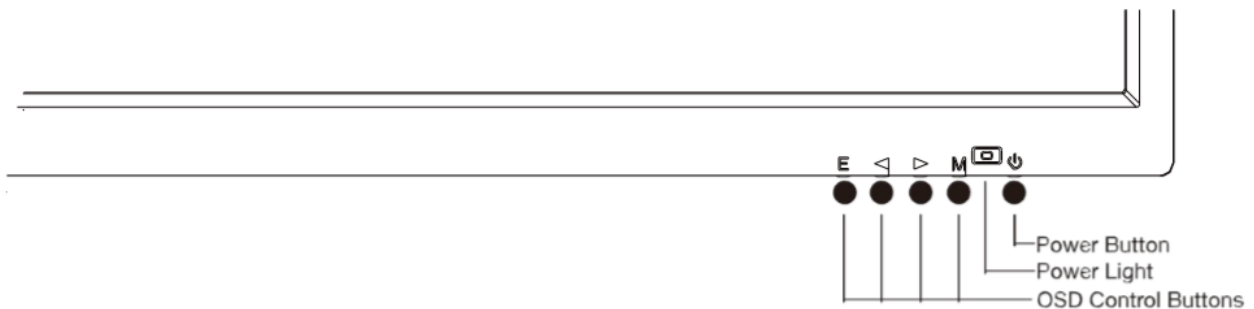

MONITOR CONTROLS



- E Select signal source or Exit the menu
- ◀ Go Up within the Main Menu or increase the value of the selected item
- ▶ Go Down within the Main Menu or decrease the value of the selected item
- M Enter the Main OSD Menu and Select submenu
- ⏻ Turn the monitor on or Off

SHORTCUT BUTTONS

The monitor includes one touch options to access common settings.

E	Display the signal source menu. Use the ◀ and ▶ buttons to navigate and the M button to select the source.	
◀	Activate the Line of Sight feature. Press again to cycle between the colours or turn off.	
▶	Activate the ECO Mode feature. Press again to cycle through the presets.	

INITIAL SETUP

Connect the monitor to a power socket.

1. Press the POWER button on the monitor or to turn it on (The indicator will be blue).
2. Connect the relevant cable to the corresponding input on the monitor. The source will be automatically detected.
3. To change between inputs, press the E button to enter the source menu. Use the ◀ and ▶ buttons to choose the input source between DP1, HDMI1, HDMI2 and DP2.



MENU OPTIONS

The menu for the monitor can be accessed by pressing the menu button on the control panel. This menu is separated into the following sub menus: Input source, Brightness/Contrast, Colour Settings, Picture Quality Settings, Display, Audio, OSD (On screen display), and other. Details of each menu can be found in the following section.

OSD MENU

INPUT SOURCE

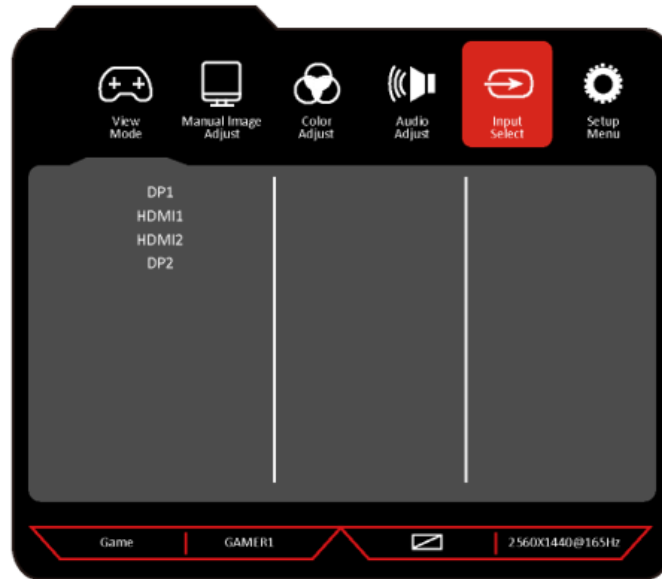

Signal	Switch the signal input or select the source. DP1, 2, HDMI1, HDMI2
--------	--

COLOR SETTINGS

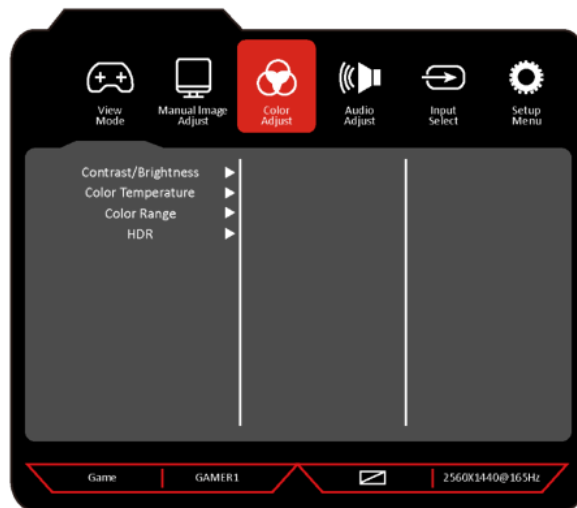

Brightness	Adjust the brightness of the display between 0 and 100.
Contrast	Adjust the contrast of the display between 0 and 100.
HDR	The HDR is divided into, Auto (HDMI), HDR Effect
Colour Temperature	Change the Colour Temperature of the display to Normal, Warm, Cool or User. When the User Mode is selected, the Red, Green, and Blue values can be adjusted independently between 0 and 100.

MANUAL IMAGE ADJUST

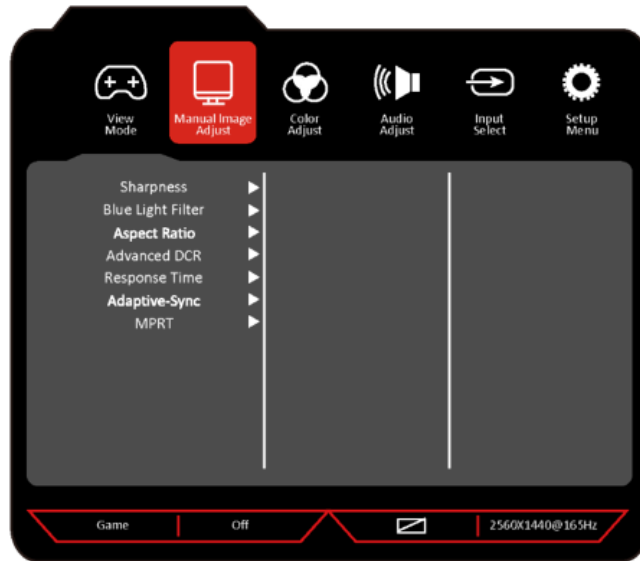

Aspect Ratio	Change the image aspect ratio to Wide Screen, 4:3,5:4,16:9,16:10, Auto.
Sharpness	Change the clarity from 0 to 100.
Blue light filter	Change the display blue light from 0 to 100.
Advanced DCR	Turn the Dynamic Contrast Ratio Feature On or Off.
Response time	Turn the Response Time feature On or Off.
Adaptive sync	Turn the Adaptive-Sync feature On or Off.
MPRT	Turn the MPRT feature On or Off.

AUDIO

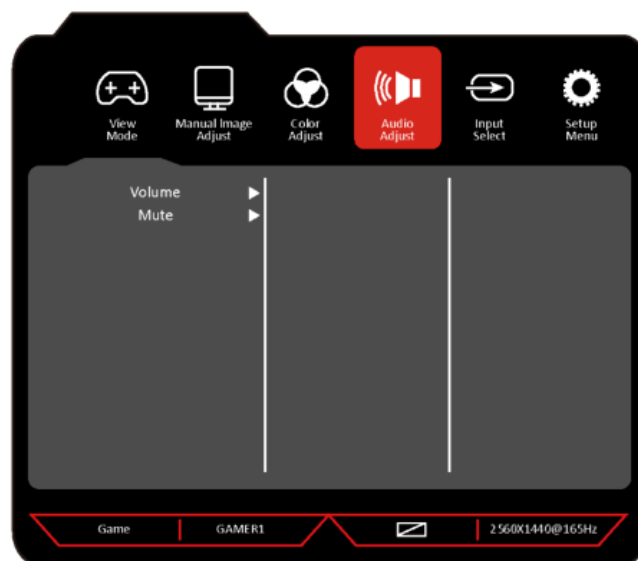

Mute	Turn On and Off to mute and unmute the audio output.
Volume	Adjust the output volume between 0 and 100.

SETUP MENU

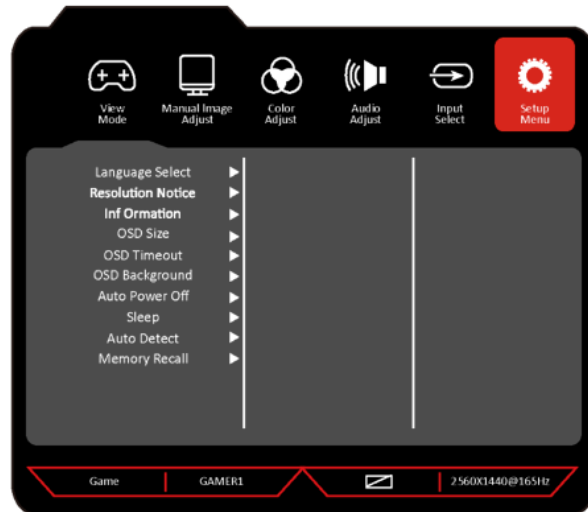

Language	Change the OSD Menu display language between English, Chinese, Korean, Russian, Spanish, Japanese and French.
Resolution Notice	Turn the Resolution Notice feature On or Off.
Information	Resolution:1920x1080 Horizontal frequency: 137.36KHz Vertical frequency:120.0Hz Clock frequency:285.5MHz.
OSD Size	Menu shows budget, large.
OSD Timeout	Change the OSD Timeout from 0 to 100.
OSD Background	Turn the OSD Background feature On or Off.
Auto Power Off	Turn the Auto Power Off feature On or Off.
Sleep	Sleep time is 30,45,60,120, off.
Auto Detect	Turn the Auto Detect feature On or Off.
Memory Recall	Restore factory default setting.

OTHER

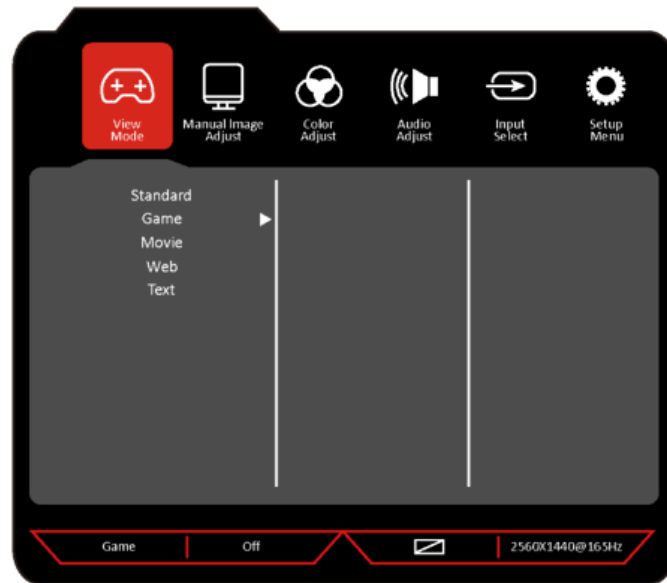

Standard	Enter standard mode.
Game	The game mode is divided into FPS1, PFS2, RTS, Night, Vision, Gamer1, Gamer2, Gamer3.
Movie	Enter movie mode.
Web	Enter Web mode.
Text	Enter text mode.

SPECIFICATION

eiQ-32CVQ165VAFSGH	
Panel Type	32" (16:9) LED Backlit Monitor
Panel Dimensions	800.1mm Diagonal
Case Type	Plastic
Best Resolution	2560(H)x1440(V)@165Hz
Active Display Area	697.344(H)x392.256(V)
Pixel Pitch	0.272.4(H)x0.272.4(V)
Contrast Ratio	3000:1 Typical
Brightness	300 cd/m ²
Response Time	5ms (GTG)
Viewing Angle	178°/178° CR≥10
Display Colours	16.7M
Video Compatibility	Multi-Standard for NTSC / PAL
Aspect Ratio	16:9
Speaker Multimedia Speakers	2x3W
Sound Demodulation	Stereo. Audio
Operating Humidity	20%-70%
Operating Temperature	-10 to 50°C
IN/OUT INTERFACE	
Video Interface	HDMIx2, DPx2
Audio Interface	Audio out x1
Safety & EMC Certification	CE/FCC/ROHS
Stand Type	Desktop
Button Position	Right Hand Side
Power Input	DC 12V 5A
Power Consumption	≤48W

TROUBLESHOOTING

Problem	Solution
No power	Insert the plug securely into the power outlet.
No picture	Ensure that the equipment is connected properly.
	Ensure the correct input is selected.
Buttons on the monitor don't do anything	Disconnect the power plug and then reconnect it. (The unit may not be operating properly due to lightning, static, or other factors.)
Noise or other interference	Electronic equipment near the unit may be causing interference. Relocate the unit or move the equipment.

ENVIRONMENTAL PROTECTION



Recycling facilities are now available for all customers at which you can deposit your old electrical products. Customers will be able to take any old electrical equipment to participating civic amenity sites run by their local councils. Please remember that this equipment will be further handled during the recycling process, so please be considerate when depositing your equipment. Please contact the local council for details of your local household waste recycling centers

electriQ UK SUPPORT

www.electriQ.co.uk/support

Call: 0871 620 1057

Office hours: 9AM - 5PM Monday to Friday

www.electriQ.co.uk

Unit J6, Lowfields Business Park
Lowfields Way, Elland
West Yorkshire, HX5 9DA