



**Antibacterial desiccant Dehumidifier
with humidistat and laundry mode**

DESD10L

USER MANUAL



Thank you for choosing ElectriQ

**Please read this user manual before using this innovative Dehumidifier
and keep it safe for future reference**

Visit our page www.electriQ.co.uk for our entire range of Intelligent Electricals

Contents

Safety instructions	2
Features	4
Parts	5
Control panel	6
Quick operation guide	7
Operation	9
Positioning	12
Water Drainage	13
Care and Maintenance	16
FAQ	17
Troubleshooting	19
Technical Data	21

SAFETY INSTRUCTIONS

Important

- Carefully read the instructions before operating the unit
- This appliance is for indoor use only and intended for use in a domestic environment only. Any other use is not recommended by the manufacturer and may cause fire, electrical shocks or other injury to person or property.
- Rating: This unit must be only connected to a 220-240 V / 50 Hz earthed outlet.
- Installation must be in accordance with regulations of the country where the unit is used.
- If you are in any doubt about the suitability of your electrical supply have it checked and, if necessary, modified by a qualified electrician.
- This dehumidifier has been tested and is safe to use. However, as with any electrical appliances - use it with care.
- Disconnect the power plug from socket before dismantling, assembling or cleaning.
- Avoid touching any moving parts of the appliance.
- Never insert fingers, pencils or any other objects though the guard
- This appliance is not intended for use by persons (including children) with reduced physical, sensory or mental capabilities. It is also not intended for use by those with a lack of experience and knowledge, unless they have been given supervision or instruction concerning the use of the appliance by a person responsible for their safety.
- Do not leave children unsupervised with this appliance.
- Do not clean the unit by spraying it or immersing it in water.
- Never connect the unit to an electrical outlet using an extension cord. If a power outlet is not available, one should be installed by a qualified electrician.
- Never operate this appliance if the cord, power adapter or plug is damaged. Ensure the power cord is not stretched or exposed to sharp object/edges.
- A damaged power supply cord should be replaced by the manufacturer or a qualified electrician in order to avoid a hazard.
- Any service other than regular cleaning or filter replacement should be performed by an authorized service representative. Failure to comply could result in a voided warranty.
- Do not use the appliance for any other purposes than its intended use.
- Do not tilt the unit while in use. The unit is design to work only in vertical position.
- This dehumidifier must always be stored upright, otherwise irreparable damage may be caused
- This unit will still operate for approximately 3-4 minute after pressing the power off button. This is normal and ensures the desiccant wheel is drained of water. Avoid restarting the dehumidifier unit unless 5 minutes have passed since being turned off.
- Never use the mains plug as a switch to start and turn off the dehumidifier. Use the provided ON/OFF switch located on the control panel.
- Always place the unit on a dry and stable surface.
- The appliance should not be installed in laundry or wet rooms where the humidity is higher than 85% RH. Operate this unit in an ambient temperature between 1°C and 32°C.

- Do not dry laundry above the unit to prevent water entering the dehumidifier. Place the laundry at least 40 cm away from your dehumidifier.
- Do not place the unit next to heat sources (e.g. electrical fires, fireplaces, etc.)
- Desiccant dehumidifiers tend to absorb odours from the surrounding environment like cigarettes, cooking, cosmetics, new furniture etc. This smell described as a burning smell or sour smell is released during operation as the zeolite disc is heated during operation. This is not sign of a fault and the smell will fade with the time.
- Do not store or use gasoline, petrol, paint, solvents or other flammable vapours and liquids in the vicinity of this dehumidifier or any other appliance. Do not use dehumidifiers where flammable gases or VOC can be released or accumulate.

Energy Saving and Unit Safety Protection Tips

- Do not cover or restrict the airflow from the outlet or inlet grills.
- For maximum performance the minimum distance from a wall should be 20 cm and 40 cm from objects
- Keep the filters or grills of the unit clean. Under normal conditions, filters or grills should only need cleaning once every three weeks (approximately). Do not use the unit without the mesh air filter as this will allow dirt to gather inside the dehumidifier and could invalidate the warranty. A dirty filter will restrict the air flow into the machine which will increase the resistance on the fan and could result in damage and might invalidate the warranty. Since the filters remove airborne particles, more frequent cleaning maybe necessary, depending on the air quality. Vacuum and wash the mesh filters with hot soapy water and dry them before placing them back in the unit.

Quick visual guide on where not to use your dehumidifier

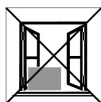

Exposed to the weather outdoors



Near water



If the power cable wires are frayed or cut



Where small children may be left unattended

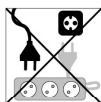

If an extension lead may become overloaded



Where the power cable may be damaged

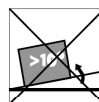

On a slope or uneven surface



Where there is risk of fire or close to a naked flame



Where it may be damaged by chemicals

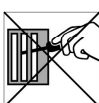

Where there is a risk or interference by foreign objects



This product is not made for DIY repair



If there is a risk of water falling on the unit

Features

Your ElectrIQ dehumidifier is a top of the range desiccant dehumidifier with features not found in other units

1. Efficient, easy to use, quiet
2. Intelligent CPU controlled digital humidistat with 4 humidity settings 40%, 50%, 60%, 70% RH and room humidity display
3. Easy to use control panel with led indicators
4. Works very well at low temperatures compared with classic compressor dehumidifiers
5. Desiccant Dehumidifiers are very effective at low temperatures and do not lose their ability to dehumidify effectively
5. Laundry mode to help clothes drying
6. Heats the air passing through between 5-10°C, making the air dry and warm reducing the heating bills
7. Side large water tank with easy to carry handle
8. Tank full alarm & auto-stop function
9. Antibacterial filter sterilizes the air
10. Recessed carry handle for portability
11. Anti-tilt safe design

ElectrIQ desiccant dehumidifiers use compressor free desiccant technology to extract water from the environment. The desiccant dehumidifiers are ideal both at standard and low temperatures working on ambient range between 1-32°C. ElectrIQ desiccant dehumidifiers are light and easy to move around as they do not have heavy compressors. They are also intelligent dehumidifiers which will extract unwanted humidity while saving money due to their humidistat and advanced power saving logic. They features an intelligent digital humidistat with variable humidity settings at 40%, 50%, 60%, 70% RH insuring your room is not dried too much and power is not wasted. The DESD10L also features a powerful laundry mode. Quiet vs turbo operation ensures the right balance between quiet operation and maximum dehumidification.

Installation

Remove any water from the water tank before starting the unit. In order to save energy, do not open windows or doors while the unit is running. Place the unit on a hard / flat surface. On first use run the unit continuously for 24 hrs.

To reduce noise levels

Place a piece of carpet or a rubber mat under the unit to reduce any vibrations while the unit is running.

PARTS

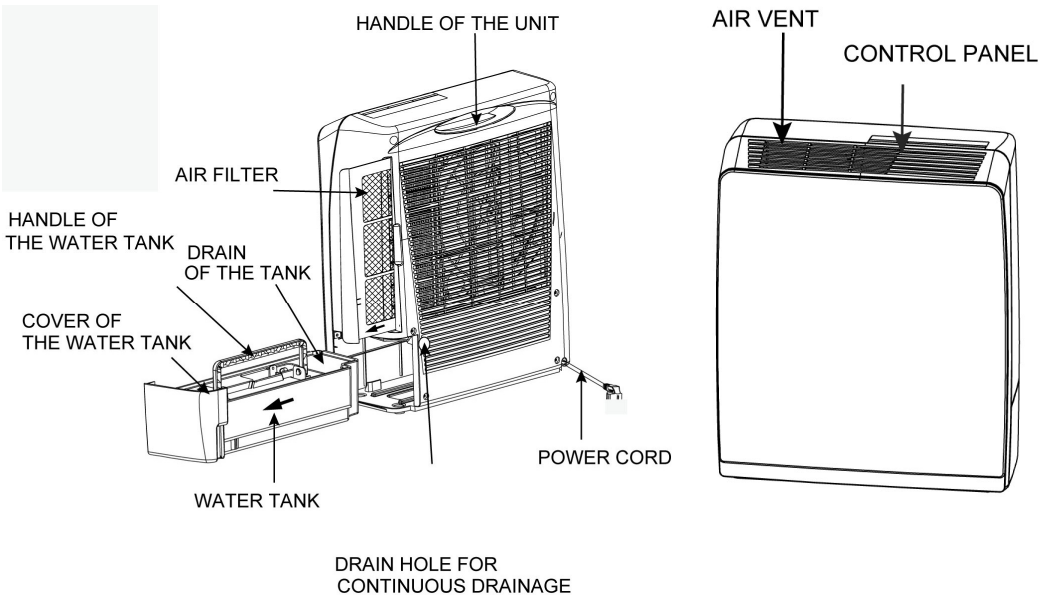



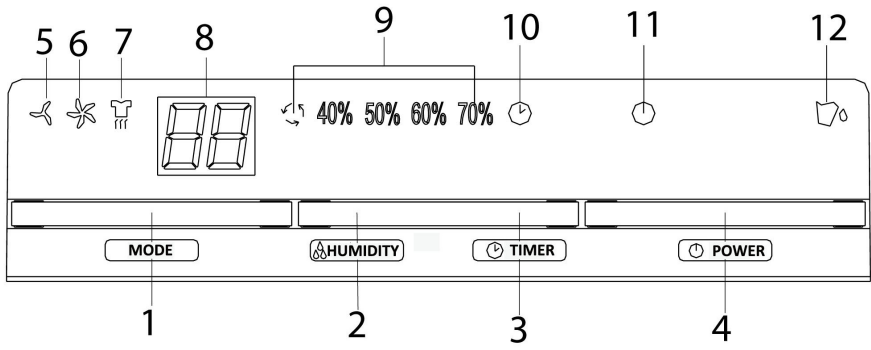

- (1) Recessed carrying Handle
- (2) Air inlet and grill (back)
- (3) Washable anti-bacterial mesh air filter and optional carbon filter
- (4) Water tank with cover and handle
- (5) Continuous Drainage Hole
- (6) Control panel
- (7) Vent with air outlet grill
- (8) Power cord
- (9) Power plug (varies according to region)

CONTROL PANEL









Operating Keys

1-4 Operation Keys

- (1) **Mode selection** Quiet, Turbo or Laundry   
- (2) **Humidity selection** 40-70% and continuous mode 
- (3) **Timer** 0-24 hrs
- (4) **Power ON** key

5-12 function indicator led lights



- (5) **Quiet mode** 
- (6) **Turbo mode** 
- (7) **Laundry mode** 
- (8) **Humidity and timer display** shows room humidity or set timer
- (9) **Humidity selection led lights** 40-70% RH and continuous mode 
- (10) **Timer on led light** 
- (11) **Power on led light** on for normal operation
- (12) **Tank Full led light**  red if tank full or not properly in place

Quick Operation Guide

Power On / Off Key (4)

Turns the unit **ON** / **OFF**. The power on led light **(11)** will stay on during operation

Mode Selection (1)

Press mode key **(1)** and the dehumidifier will cycle between **Quiet**  , **Turbo**  and **Laundry mode**  with led lights showing the respective icon

Quiet mode  unit will work with fan in **LOW** mode and the humidistat will turn the heating element on while room humidity is higher than the set humidity level than will work in low fan mode until humidity increases again

Turbo mode  unit will work with fan in **HIGH** mode and the humidistat will turn the heating element on while room humidity is higher than the set humidity level than will work in low fan mode until humidity increases again

Laundry mode  Heater and fan are both on all the time to achieve maximum dehumidification and dry the clothes. Humidistat is disable in this mode

Note: If continuous mode  is selected the humidistat will be disabled and **quiet or turbo** mode will only select the fan speed

Timer Selection Key (3)

Selects the stopping timer to 1-24 hours by pressing the **(3)** key. The two digits led display will show the timer selection instead of the room humidity while key **(3)** is used. 8 seconds after timer selection the display will revert to room humidity display.

The unit will stop after so many hours as selected. This function is great if you use **Laundry mode** and want to stop the unit e.g. after 4 / 8 hrs.

 **(10)** led is lighten up while the stopping timer is selected

Dehumidification Level Controls Keys (2)

Use the key **(2)** to select between continuous mode  and 40-70% humidity. If no selection is made the unit will work with pre-set to 50%RH which is the recommended setting.

Continuous mode  humidistat is disabled, unit will dry until set time or tank full. Humidity set to **40% RH**; set to achieve room humidity of around 40% good for quick drying boost on initial run or emergencies, not recommended for long normal operation in domestic environment.

Humidity set to **50% RH**; recommended setting, great for domestic operation and dry storage.

Humidity set to **60% RH**; great for personal comfort and applications where 50% RH is considered too dry.

Humidity set to **70% RH**; ideal for unoccupied properties or where economical run is needed without the need to go drier than 70% RH.

Indicator led lights

(5) Quiet mode  lightens when quiet low fan mode is selected.

(6) Turbo mode  lightens when turbo high fan mode is selected.

(7) Laundry mode  lightens when laundry mode is selected.

(8) Humidity and timer display two digits led display shows room humidity (35-95%RH) or set timer.

(9) Humidity selection shows 40% 50% 60% 70% and continuous mode  according to key **(2)** selection.

(10) Timer on led light  lightens while stopping timer is in operation off if the timer is not activated.

(11) Power on led light

Lightens continuously if unit is operating normally.

The led indicator will blink intermittently when the unit is tipped over or when the unit is turned off but the fan continues to operate for few minutes to dissipate the heat and empty the desiccant disc.

(12) Tank Full led light  red light on if tank full and required to be emptied if not pushed in correctly.

NOTES: This unit is equipped with tilt protection. When the unit is tilted will stop automatically, the POWER indicator will turn into RED and the unit will beep 3 times. After repositioning the unit, press **Power** key to restart.

DESD10L has intelligent self-diagnosis. If the humidity sensor, heating element or tip-over device is out of function, the unit will beep 3 times, the POWER indicator would turn RED and the unit will turn OFF.

OPERATION

Switching the unit ON and OFF

Press the “ON/OFF” switch to turn on the unit. The power light will be green as soon as it switches on. To turn off the unit press the “ON/OFF” key again.

Please note that when turning it off, the dehumidifier will still operate for a while to discharge the remaining water from the desiccant disk and prevent mould growth.

Setting the Laundry Mode

Press mode selection until laundry led  will turn on. Laundry mode will set the fan and heater on to maximum and humidistat control will be disabled.

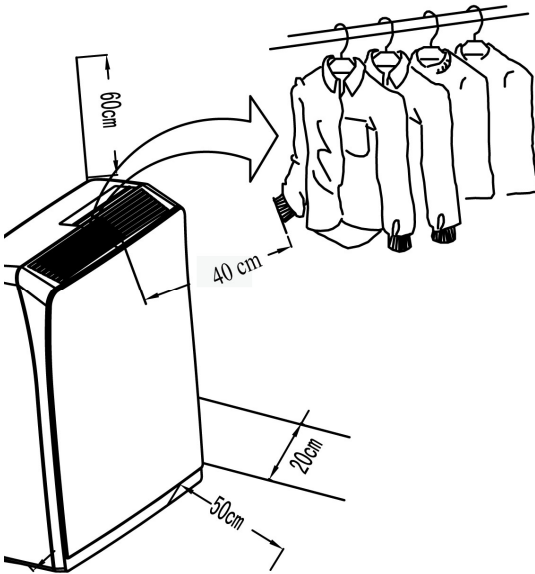

Do not dry laundry above the unit to prevent water entering the dehumidifier. Place the laundry at least 40 cm away from your dehumidifier. Direct the unit with front vents towards the clothes ainer or hanging clothes. Hot dry air comes from a 45 degrees angle. Laundry mode can be used in conjunction with the stopping timer.

Setting the Stopping Timer

On selecting stopping timer key **(3)** the 2 digits LED display will cycle through 1-24 showing the number hours after which the dehumidifier will stop. The displayed time will revert to humidity display 8 seconds after selection was made.

When selecting '4 hours' for example the unit will stop operating after 4 hours with selected humidity / fan settings. Tank full before the selected time will stop the unit. This setting is ideal for drying laundry. No selection made will mean the unit operates continuously subject to tank full stopping the unit earlier.

Press timer key again at any time to cancel or change the timer settings

Setting the Dehumidification level

Start the unit and leave it for 5-10 minutes on automatic selection mode (50%RH) until the humidistat is able to read correctly the humidity in the room.

Press dehumidify level key **(2)** to select the desired humidistat controls from continuous operation to 40% 50% 60% 70%.

While pressing the selection key **(2)** the corresponding indicator **(9)** cycles the humidistat set range for this unit from 40% through 50% 70%, 60% back to continuous mode.

Intelligent dehumidification and power saving

Your ElectriQ dehumidifier features an intelligent micro CPU that ensure maximum water extraction with minimum power use for the selection made.

The unit will try to maintain humidity level selected in the room by turning off the heating element when the desired humidity is reached. Note that according to the space where the unit is used, obstacles in the direct flow, extra humidity being added at any time, settings selected, as well as other environmental factors the results may vary.

Operational Advice

1. Plug to power, press ON/OFF key to turn-on the machine; press ON/OFF key again to turn-off the dehumidifier.
2. Make sure water-tank is placed/ fitted correctly. If the water tank is not fitted/placed correctly the 'water full' **(12)** light  will turn on and the machine will not operate.
3. When the dehumidifiers first starts, default humidity setting is set to 50% RH.
4. When unplugging from the wall socket use one hand to hold the plug and the other hand against socket to avoid power cord damage.
Warning: Using poor quality sockets, extensions or overloading the circuits may cause damage to the machine or may start a fire.
5. When switching OFF the machine, do not simply unplug the unit from the socket - ensure you turn off the machine properly before unplugging. After dehumidifiers is OFF, the fan will keep running for a couple of minutes and heat will be produced to dry the dehumidifier.

Tilt Protection

Your ElectrIQ dehumidifier was designed with safety in mind. When unit is tilted it will be shut down to minimize safety risk or damage. Please do not use if the unit is tilted by mistake for a day or two until the internals are completely dried. Consult the service centre if in any doubts

Positioning the dehumidifier

Badly positioned dehumidifiers will have little effect in effectively drying the place. In positioning the dehumidifier please ensure circulation of air in not restricted around the unit. Please observe figure bellow in installing the unit.

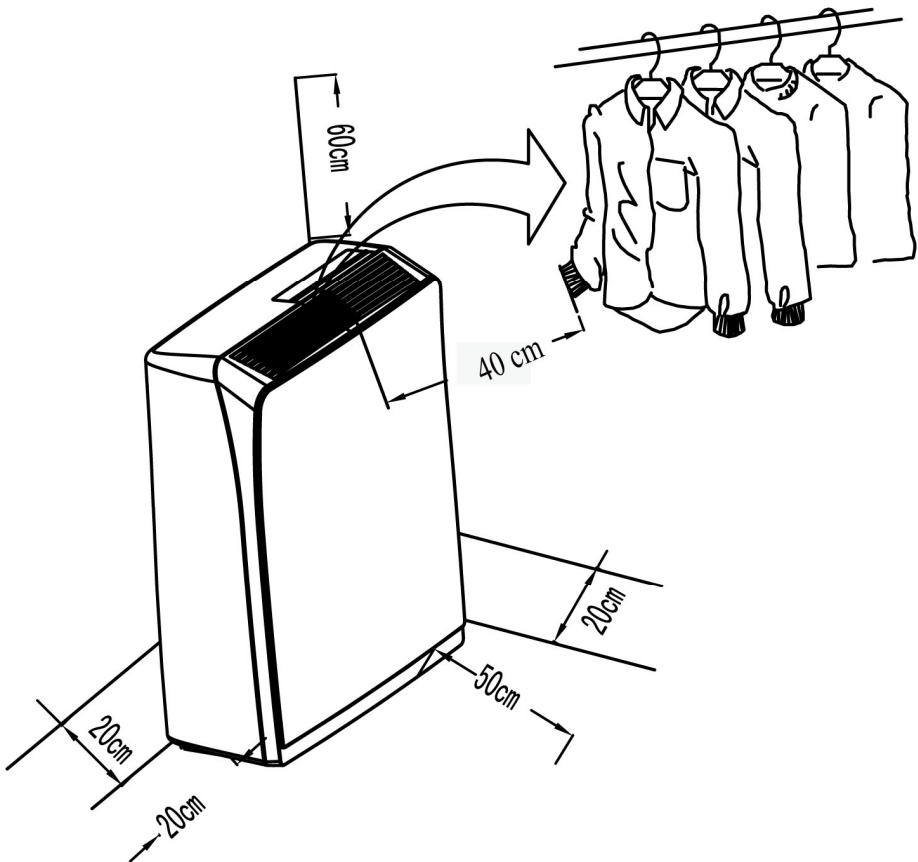

Your ELECTRIQ dehumidifier will begin to protect your home from the harmful effects of excessive moisture as soon as it is turned on.

Excess moisture travels throughout your home, in the same way that cooking smells spread around the house. For this reason, the dehumidifier should be positioned in a central and clear location so that it can draw this moist air

towards it from all over the home. A warm hallway or landing is an excellent position for your dehumidifier. If possible, leave interior doors ajar to allow air circulation.

Alternatively, if you have a serious problem in one area you can begin by positioning the dehumidifier there and moving it to a more central location at a later date. For the most effective use, run your dehumidifier with external doors and windows kept closed. Please note the unit should not be placed directly against a radiator or other heat source.

When positioning your ELECTRIQ dehumidifier, ensure that it is placed securely on a level surface clear of any obstacle that may limit the air movement.

This dehumidifier is designed only for indoor residential / office applications and any commercial or industrial use will invalidate the warranty. Place the dehumidifier on a flat dry surface. Do not use outdoors.

Water Drainage

When the water tank is full, the unit will stop automatically. When this happens the water full indicator light  will show on the control panel. There are two ways to dispense collected water.

Use the tank

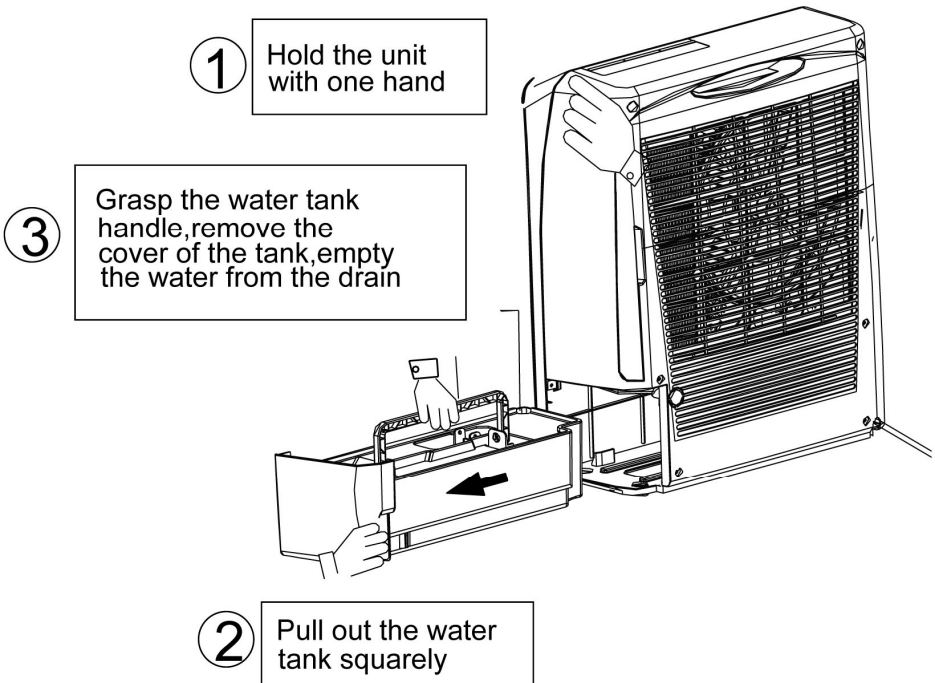

When the tank is full, the unit will automatically stop running, and the Full indicator light will flash. Slowly pull out the tank with one hand while keeping the unit in place with the other hand. Hold the bottom of water-tank to pull it out by recessed handle. Carry the tank by the pull out handle and remove the tank cover only before emptying it. Empty the water tank and reinsert it into the dehumidifier. The tank must be in place and securely seated for the dehumidifier to operate again. The dehumidifier will re-start when the tank is restored in its correct position.

Notes:

- Do not remove the water tank immediately after the unit stops. Please wait a while to avoid the water dripping into the unit and causing damage.
- Only empty the water tank when is full or before moving or storing the unit.
- Do not rest the tank on the floor because the bottom of the tank maybe uneven and tank will fall and cause the water to spill.
- When you remove the bucket, do not touch sensors or any parts which are situated behind tank. Doing so may damage the product. Be sure to push the tank gently all the way into the unit. Banging the bucket against anything or failing to push it in securely into place may cause the unit not to operate.
- Do not remove or damage the float switch in water-tank, otherwise the machine will stop working.
- Please make sure the water tank cover is put back into place correctly before the water tank is reinserted.
- If the water-tank is inserted incorrectly, the tank full indicator will not turn off. Reinsert the water tank to turn the indicator off and resume normal use.
- At all times, avoid water entering the unit. It may cause electrical hazard and damage the unit.

Continuous draining

This dehumidifier has a continuous drain hole that can be connected with an optional plastic pipe with 12 mm inner diameter. The water in the body will drain through the drain hole first, so ensure it is secured with the rubber stopper if using the water tank.

Water can be automatically plumbed in or drained into sink, a larger recipient or through the wall into an outside drain by attaching a pipe to the unit.

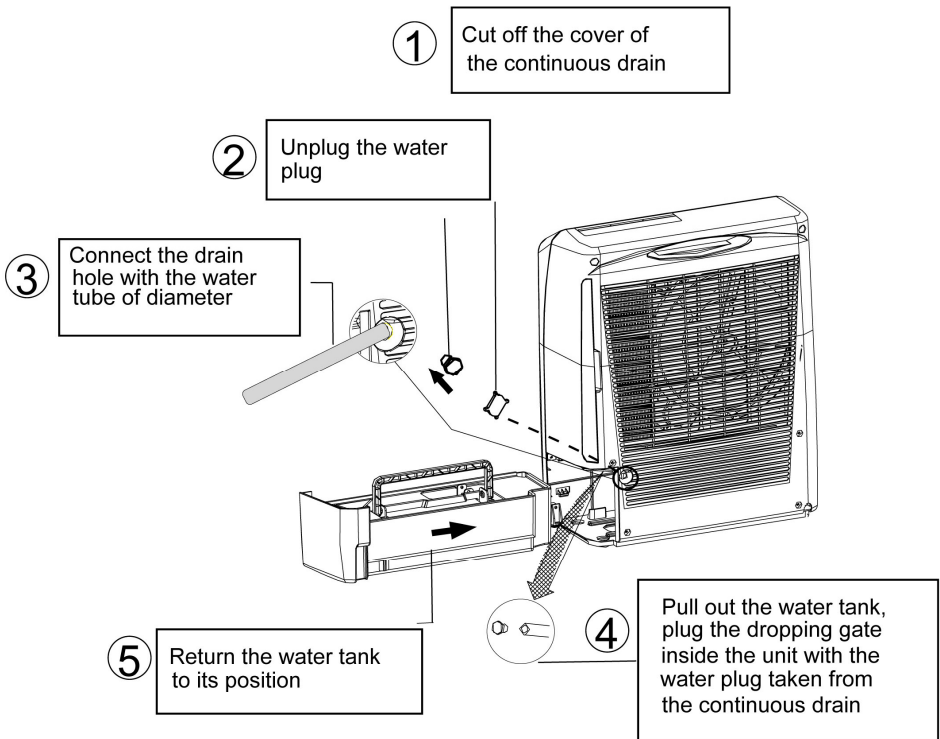

Remove the plastic cover over the continuous drain. Pull out the rubber plug from the drain outlet in the back of the unit. Then insert the pipe into the drain outlet at the back of the unit. Make sure the connection between pipe and the drain outlet is tight and do not leak. Remove the tank and use the rubber bung to seal water hole inside the unit. Put back the tank in the place. Then direct the pipe to a suitable drainage point. This unit uses gravity fall to dispose water hence the drain should be lower than the dehumidifier water outlet.

Be sure to run the water pipe downward and let the water to flow out smoothly. Do not kink or bend the pipe.

NOTE: When the continuous drain feature is not being used, reverse the pipe installation, remove the drain hose from the outlet and attach the rubber plug back to the drain outlet

The permanent drain can be used in conjunction with water pump (e.g. when draining a cellar) to lift the water upwards.

Care and Maintenance

Always switch off the unit and unplug from the mains before cleaning or performing any maintenance. When it is not in use for long periods it is advised to remove the plug from the plug socket. Do not use chemical solvents (such as benzene, alcohol or gasoline) as they may cause irreversible damage to the unit.

Filter Cleaning

Air-inlet and air-outlet may gather dust easily, please clean it often with a soft, damp cloth. If the filter is covered by dust, the airflow and the performance of the unit will be affected, it may even cause machine damage. We recommend that you regularly clean the filters. Disconnect the dehumidifier from socket before maintenance and let it dry before reuse.

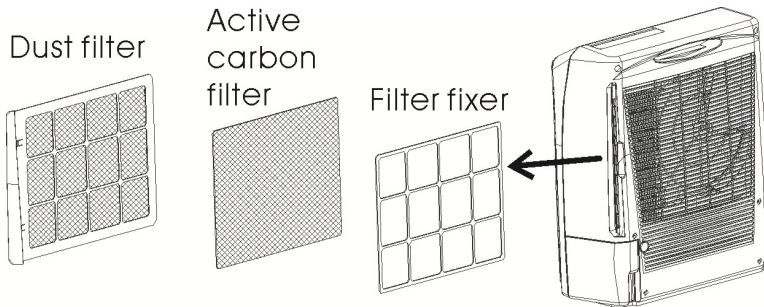

1. Remove the filters from the unit. Tap the dust away first.
2. Clean the carbon and the mesh filter with a vacuum cleaner or soft-brush
3. If dirt and grease is accumulated wash the mesh filter in hot soapy water
3. Replace the filter in position as shown in the diagram above

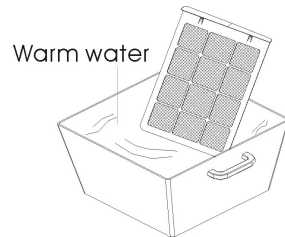

Note: Never use the unit without the antibacterial mesh dust filter. The active carbon filter is optional and should be replaced if necessary after 1-1 ½ years of usage.

Grille and Case Cleaning

Use water and a mild detergent. Do not use bleach or abrasives. Do not splash water directly onto the main unit. Doing so may cause an electrical shock and can lead to the insulation to deteriorate, or cause the unit to rust. The air intake and outlet grilles get soiled easily, so use a vacuum attachment or soft brush to clean.

Water tank cleaning

Every few weeks, clean the tank to prevent growth of mould, mildew and bacteria. Partially fill the tank with clean water and add a little mild detergent or light bleach solution. Swish it around in than empty the tank and rinse.

NOTE: Do not use a dishwasher to clean the tank. After cleaning and drying the tank must be reinserted securely into dehumidifier in order to restart operation. Only use soft wet cloth or paper towel. Do not use detergent or very hot water.

Out of season storage

1. Turn off the unit and wait for the drying cycle to finish before unplugging the power cord.
2. Clean and dry the water-tank.
3. Clean the filter, air-inlet, air-outlet and unit body.
4. Cover the unit to prevent it from gathering dust.
5. Store the dehumidifier in a cool and dry place.

Power Cord Maintenance and Replacement

If the power cord is damaged, it could cause a short circuit or become a fire risk. Please avoid pulling the cord, twisting or pressing it and keep it away from pets. If the power cord is damaged, power the unit off and unplug if immediately. Contact an electrician or service centre for repairs; do not attempt to repair the unit yourself.

Frequently Asked Questions

Smells and odours

On first use the dehumidifier and periodically afterwards you might notice a smell coming from the dehumidifier. This is caused by the Zeolite desiccant material and is not a sign that the dehumidifier is faulty, nor is it harmful to humans or pets. The smell occurs because the desiccant disc absorbs odours from ambient like cooking smells, cigarettes, cosmetics, hair sprays, building materials and new furniture and then when the desiccant is heated the smell is discharged back into the room. This smell has been described as being like a burning smell or acrid smell. It is normal, will not last long and is not a sign of a fault. You can clear it by running the dehumidifier in a separate ventilated space like a garage or if it is dry – outside.

Amount of water collected and size of the tank

- When you first use your dehumidifier it will work harder to reduce the room humidity down to 50%RH (default mode or set to continuous or 40%RH). This is the time when it will produce the most water and need emptying most frequently even 2-3 times / day. As the room becomes dryer the dehumidifier collects less water and will takes longer to fill the tank, this is perfectly normal. When the target relative humidity has been reached the dehumidifier will stop collecting water and going longer in fan only mode, this is normal operation. The intelligent logic of your machine will save you money.
- Unless you dry clothes, we recommend to use the unit in 50-60%RH
- If you find that you still have condensation on your windows or you need to dry the air further then us the 40%RH or continuous mode with fan set to turbo mode. This might well be necessary if you have single glazed windows, house that is poorly insulated or if the outside air temperature drops towards freezing. Using in Turbo mode will add more heat to your room and reduce your heating bill as dry air will heat quicker.
- For unoccupied properties, garages, etc. use 60-70% RH with fan in Turbo or Quiet mode according to your needs. That will ensure minimum power consumption while will prevent moisture related issues.

Troubleshooting

Problem	Possible Cause	Solution
The unit does not work	<ol style="list-style-type: none"> 1.Power is abnormal 2.Water tank displaced or full 3.Room temperature is too high or air-outlet is covered 	<ol style="list-style-type: none"> 1. Contact an electrician to perform a repair. 2.Check water tank placement or empty water tank 3. Lower room temperature, clear air outlet
Poor performance	<ol style="list-style-type: none"> 1.Filter is dirty 2.Door & windows are open 3. Air-inlet or out-let is blocked. 	<ol style="list-style-type: none"> 1.C lean the filter 2.Close door & windows 3.Clean air-inlet & air-outlet
Too Noisy	<ol style="list-style-type: none"> 1. Unit is not placed on even surface. 2. Filter is blocked 	<ol style="list-style-type: none"> 1. Place the machine on the flat surface. Add carpet or rubber mat underneath 2. Clean the filter
The device does not dehumidify	The relative humidity in the room where the dehumidifier is operating is too low.	The dehumidifier dries down to the target relative humidity set and then goes into fan only mode until the relative humidity goes above the set point again.
The dehumidifier works, but relative humidity is still high	<ol style="list-style-type: none"> 1. The place is too large. This dehumidifier can dry up to about a small six bedroom house. 2. There are too many sources of moisture. Bathing, washing, drying clothes and cooking all puts moisture into the air. 3. Paraffin or Calor gas heating can add too much moisture into air 	<ol style="list-style-type: none"> 1. We recommend using a dehumidifier with a greater capacity. Call customer service line for advice 2. We recommend using a dehumidifier with a greater capacity. 3. Consider using an alternative heat sources
The windows were clear and now condensation has returned.	The outside air temperature has dropped significantly and the windows are colder.	Set the dehumidifier to 40%RH or Laundry and run for longer
I cannot remove the condensation from my windows, even in "Continuous" or "Laundry" mode	The surface temperature of the windows is too low for a dehumidifier to prevent condensation. Common with single glazed windows or poorly insulated houses when the outside air temperature drops below 0°C	Keep running the dehumidifier on "Laundry" 24 hours a day and if the air temperature outside increases the condensation on windows may clear
Dehumidifier is blowing out warm air	The dried air is passes over a heating element before it is blown into the room as part of the dehumidification process	This is normal and helpful especially in the cold weather, a dehumidifier is not an air cooler. You may be used with a compressor dehumidifier which may blow also cold air.
Knocking noise coming from the dehumidifier	Motor wheel is low on lubrication or dirt may have enter the motor ball bearings	Run the dehumidifier in Laundry mode for two days to increase the lubrication, if fault persists then call the call the service centre

Red warning light on continuously or flashing	Restricted airflow to the dehumidifier, overheating or temperature below freezing	<ol style="list-style-type: none"> 1. Clean the filter and make sure that the unit is more than 20 cm from a wall. 2. If the temperature is below freezing then use the dehumidifier when the space is warmer 3. if fault persists then call the call the service centre
Water not draining down the hose	Hose is fitted for continuous drainage but the water still goes into the tank	<ol style="list-style-type: none"> 1. Negative air pressure in the room is pulling the water back into the dehumidifier overflow. 2. Insert a 3 mm hole into the top of the tube 25 mm down from the spout. This will introduce air into the tube and balance out the air pressure. 3. Dirt is gather in the internal tray. May need servicing. 4. Rubber bung not placed in the internal hole beyond tank 5. if fault persists then call the call the service centre
Dehumidifier leaks water onto the floor	Usually means that the dehumidifier is not on a level surface or that the filter has not been cleaned often enough and dirt has fallen into the internal tray dehumidifier.	<ol style="list-style-type: none"> 1. Check that the water bucket is not cracked by filling it with water and placing it on kitchen paper on the kitchen side. 2. Check if filters are clean 3. if fault persists then call the call the service centre
Machine not switching off the heater when desired humidity is reached	Temperature and relative humidity sensor that reads the room reading is unable to read the correct readings	<ol style="list-style-type: none"> 1. Clean the filter and blow the air sensor with a hover or hair dryer on COLD setting to clear the sensor of dirt 2. Unplug the dehumidifier for 10 minutes to reset PCB and then turn back on. 3. if fault persists then call the call the service centre
On pressing power off fan still works for about 2-3 minutes and switches off	Unit is drying internally before going in off mode	Normal operation. DO NOT INTERFERE

Note: when the fault cannot be solved by the solutions above, please contact service centre for help, do not attempt repairs.

Disposal: Do not dispose this product as unsorted waste. Collection of such waste must be handled separately as special treatment is necessary.

Recycling facilities are now available for all customers at which you can deposit your old electrical products. Customers will be able to take any old electrical equipment to participating sites run by their local councils. Please remember that this equipment will be further handled during the recycling process, so please be considerate when depositing your equipment. Please contact the local council for details of your local household waste recycling centres.



TECHNICAL DATA

	DESD10L
Dehumidify Capacity	9-10 litres day depending on relative humidity extraction unaffected by low temperature
Power supply	220-240V AC/50HZ
Current	3.7A
Power	780 W max
Max Airflow	200m ³ / hr
Power in different Settings	470-780 W Low/High Setting
Timer	1-24 hours
Working Temperature	1-32°C
Noise	≤ 48 dB
Water tank Capacity	3.5L
Net Weight	8.5Kg
Body Size	H525 x W200 x D445 mm
DESD10L/V2DS2 2015-2016	

All information provided is for reference only. Products specifications may change due to continuous product development. All measurement are subject to tolerance.
DESD10L/V2DS_230815

ELECTRIQ UK SUPPORT

Please, for your own convenience, make these simple checks before calling the service line.

1. Has the unit been standing upright? (for at least 2 hrs)
2. Is the unit plugged into the mains? Is the fuse OK?
3. Switch the unit on and wait three minutes to see if the issue is resolved.
4. Check whether the water tank is full.
5. Have you followed the troubleshooting procedures?

If the unit still fails to operate call: 0871 620 1057 or fill the online form

Office hours: 9AM - 5PM Monday to Friday

www.ElectrIQuk.com

Unit 2, The Nursery, Berristow Lane, South Normanton, Derbyshire, DE55 2FX