



COMPRESSOR DIGITAL DEHUMIDIFIER

CD10L – 10 litres per day

CD20L – 20 litres per day

USER MANUAL

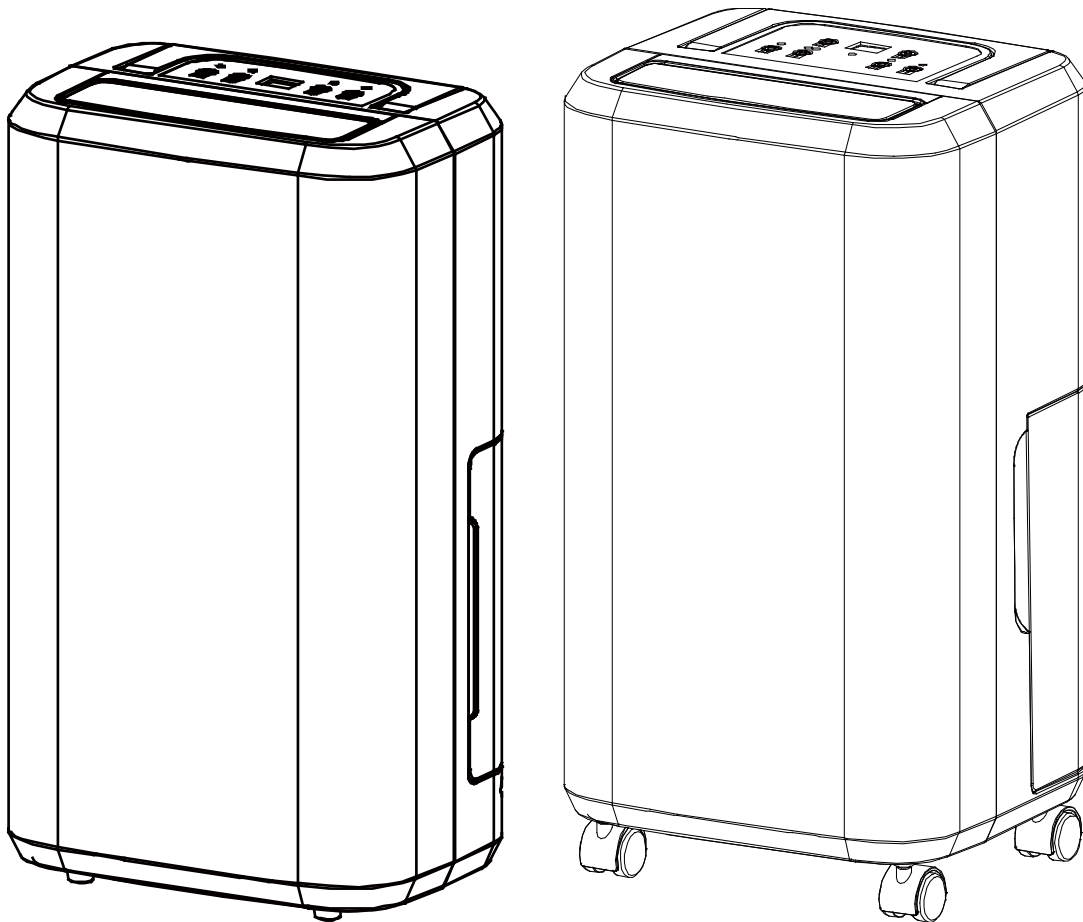

Thank you for choosing ElectriQ

**Please read this user manual before using this innovative Dehumidifier
and keep it safe for future reference**

Visit our page www.electriQ.co.uk for our entire range of Intelligent Electricals

Contents

| | | |
|-----------------------|-------|----|
| Safety Instructions | | 2 |
| Installation | | 4 |
| Parts | | 5 |
| Control Panel | | 6 |
| Quick reference guide | | 7 |
| Positioning | | 10 |
| Water Drainage | | 11 |
| Care and Maintenance | | 11 |
| Troubleshooting | | 13 |
| Technical Data | | 14 |

SAFETY INSTRUCTIONS

Important

- Carefully read the instructions before operating the unit
- This appliance is for indoor use only and intended for use in a domestic environment only. Any other use is not recommended by the manufacturer and may cause fire, electrical shocks or other injury to user or property.
- Rating: This unit must be only connected to a 220-240 V / 50 Hz earthed outlet.
- Installation must be in accordance with regulations of the country where the unit is used.
- If you are in any doubt about the suitability of your electrical supply have it checked and, if necessary, modified by a qualified electrician.
- This dehumidifier has been tested and is safe to use. However, as with any electrical appliances - use it with care.
- Disconnect the power plug from socket before dismantling, assembling or cleaning.
- Avoid touching any moving parts of the appliance.
- Never insert fingers, pencils or any other objects through the guard
- This appliance is not intended for use by persons (including children) with reduced physical, sensory or mental capabilities. It is also not intended for use by those with a lack of experience and knowledge, unless they have been given supervision or instruction concerning the use of the appliance by a person responsible for their safety.
- Do not leave children unsupervised with this appliance.
- Do not clean the unit by spraying it or immersing it in water.
- Never connect the unit to an electrical outlet using an extension cord. If a power outlet is not available, one should be installed by a qualified electrician.
- Never operate this appliance if the cord, power adapter or plug is damaged. Ensure the power cord is not stretched or exposed to sharp object/edges.
- A damaged power supply cord should be replaced by the manufacturer or a qualified electrician in order to avoid a hazard.
- Any service other than regular cleaning or filter replacement should be performed by an authorized service representative. Failure to comply could result in a voided warranty.
- Do not use the appliance for any other purposes than its intended use.
- Do not tilt the unit while in use. The unit is design to work only in vertical position.
- This dehumidifier must always be stored and transported upright, otherwise irreparable damage may be caused to the compressor; if in doubt we suggest waiting at least 24 hours before starting the unit.
- Avoid restarting the dehumidifier unit unless 5 minutes have passed since being turned off. This prevents damage to the compressor.
- Never use the mains plug as a switch to start and turn off the dehumidifier. Use the provided ON/OFF switch located on the control panel.
- Always place the unit on a dry and stable surface.
- The appliance should not be installed in laundry or wet rooms where the humidity is higher than 85% RH
- Do not dry laundry above the unit to prevent water entering the dehumidifier. Place the laundry at least 1 meter away from your dehumidifier.
- Do not place the unit next to heat sources (e.g. electrical fires, fireplaces, etc.)









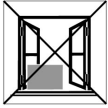

- Avoid mishandling the dehumidifier. Dropping, throwing the unit can cause damage to its internals and increases the risks of operating it.
- Do not store or use gasoline, petrol, paint, solvents or other flammable vapours or liquids in the vicinity of this dehumidifier or any other appliance.
- This dehumidifier must not be used in spaces where there is a high concentration of gases, solvent or other volatile organic compounds; in very dusty environments; in any domestic, commercial or industrial environment where air composition is flammable.

Energy Saving and Unit Safety Protection Tips

- Do not cover or restrict the airflow from the outlet or inlet grills. Do not operate and follow troubleshoot procedure if the self-opening louvers do not open on power on.
- For maximum performance the minimum distance from a wall or objects should be 20 cm
- Keep the filters or grills of the unit clean. Under normal conditions, filters or grills should only need cleaning once every three weeks (approximately).

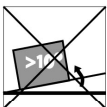
Since the filters remove airborne particles, more frequent cleaning maybe necessary, depending on the air quality. Vacuum both mesh and optional carbon filters and wash the mesh filters with hot soapy water and dry them before placing them back in the unit.

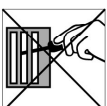
Quick visual safety guide on where or when not to use your dehumidifier

| | | | |
|---|---|--|---|
|  |  |  |  |
| Exposed to the weather outdoors | Near water | If the power cable wires are frayed or cut | Where small children may be left unattended |
|  |  |  |  |
| If an extension lead may become overloaded | Where the power cable may be damaged | On a slope or uneven surface | Where there is risk of fire or close to a naked flame |
|  |  |  |  |
| Where it may be damaged by chemicals | Where there is a risk or interference by foreign objects | This product is not made for DIY repair | If there is a risk of water falling on the unit |

Installation

Remove any water from the water tank before starting the unit. In order to save energy, do not open windows or doors while the unit is running. Place the unit on a hard / flat surface. On first use run the unit continuously for 24 hrs.

To reduce noise levels:

Place a piece of carpet or a rubber mat under the unit to reduce any vibrations while the unit is running.

CD10L & CD20L dehumidifiers use compressor technology to extract water from the environment. The compressor dehumidifiers are ideal for normal domestic or office environment which are heated during the winter months with temperatures above 12-15°C. For applications where temperature is lower than 18°C or we recommend our range of desiccant dehumidifiers.

CD10L & CD20L are easy to move around on castors and will extract unwanted humidity, with setting in increments of 5% from 30-90% RH insuring your room is not dried too much and power is not wasted.

Features

1. Easy to use controls
2. Lightweight, portable design.
3. Great for up to 3 bed (CD10L) and 5 bed (CD20L) houses
4. Cost effective way to combat mould, condensation and damp
5. Top directional dry air outlet for efficient operation and laundry mode
6. Dries laundry more efficiently than a tumble dryer
7. Designed to complement any modern space
8. Easy to carry handle
9. Castors for improved mobility (CD20L only)
10. Intelligent CPU controlled digital humidistat with 30-90% RH and room humidity display
11. Quiet fan operation ensures the right balance between low noise operation and maximum dehumidification
12. 24 hours start / stop timer
13. Tank operation or permanent drainage option
14. Tank full alarm & auto-stop function

PARTS
CD10L

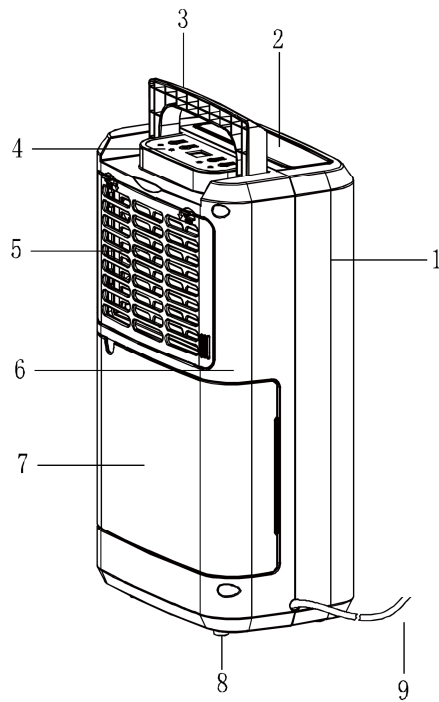

CD20L

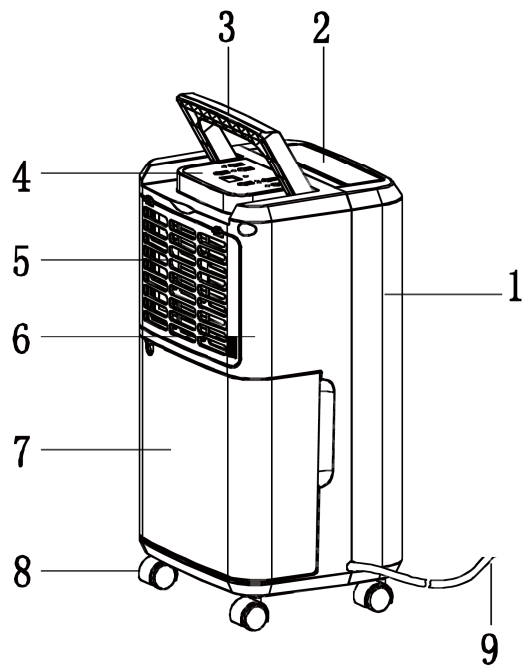

- | | | |
|------------------|------------------------------|----------------------|
| 1. Front Case | 2. Dry Air Outlet | 3. Handle |
| 4. Control Panel | 5. Air Inlet/ Filter housing | 6. Back case |
| 7. Water Tank | 8. Wheels / Feet | 9. Power supply cord |

CONTROL PANEL
CD10L

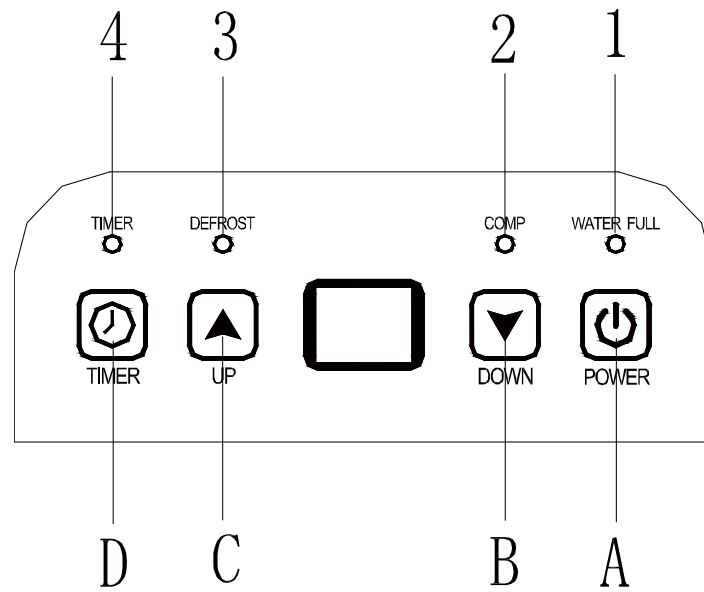

LED Indicators

1. Water Full – Red
2. Compressor on – Green
3. Defrost – Green
4. Timer – Orange

Buttons

- A. Power on/ off
- B. Down (Humidity Settings)
- C. Up (Humidity Settings)
- D. Timer

CD20L

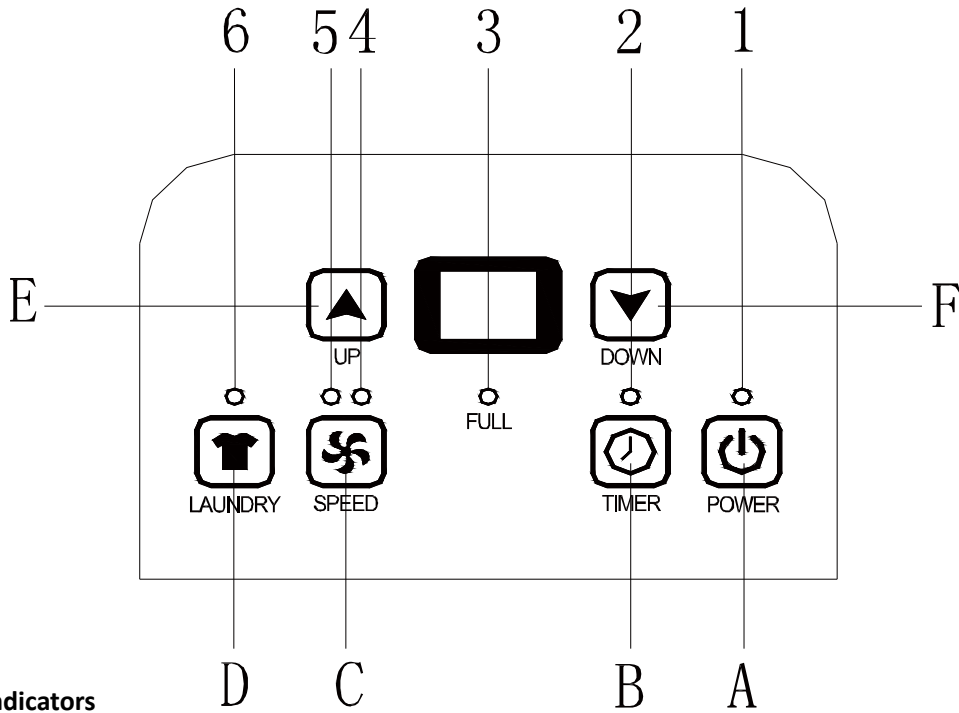

LED Indicators

1. Power indicator – Green
2. Timer – Orange
3. Water tank full – Red
4. Fan speed low – Green
5. Fan speed high – Green
6. Laundry mode - Green

| | |
|----------|---|
| | <p>POWER Turn on/off the appliance</p> |
| | <p>Timer When the unit is on standby, press the timer button to set the delay until it turns on. When the unit is on, press the timer button to set the delay until it turns off. Press the timer button to select the delay time you require in hours cycling from 0 to 24 hrs.</p> |
| | <p>Up & Down HUMIDISTAT Press to up/down arrows to select the desired humidity in the room. 50-55% is the recommended setting for normal domestic settings. The humidistat range can be selected from 30-90% RH with continuous mode option (CO)</p> |
| | <p>Laundry Mode Press this button to activate laundry mode. Laundry mode will run the dehumidifier constantly and with the highest fan setting to quickly dry your washing.</p> |
| | <p>FAN SPEED (CD20L only) Sets fans speed to Low or High</p> |

Humidity Level & Timer 2 digit display

The led indicator performs the following functions: 1. When the unit is plugged in, it will indicate the room humidity level 2. When the humidity level is selected, it will indicate the set humidity 3. When the start / stop timer is programmed will show the set timer



Notes: When humidity level is outside the normal operational parameters will show LO/HI. If ambient humidity is lower than 35%, it will show "LO" If ambient humidity is higher than 95%, it will show "HI". Also the display will show the error codes.



Quick Reference Guide

Power Key Press  to turn the dehumidifier on and off.

Timer: select timer settings key  to adjust the timer (1-24 hrs, start/ stopping timer). In power on mode the set number will represent the number of hours the unit will run for before turning off. This will remain unaffected if unit goes in to defrost mode or the tank is emptied then reinserted. In standby mode the set number represents the period in hours after which the unit will start. To cancel start / stop mode press the timer key again until is set to 0.

Press **Up**  or **Down**  Settings Key when the unit is displaying the current relative humidity to select the desired humidity level. Humidity level can be set within a range of 30% RH (Relative Humidity) to 90% RH in 5% increments.

When the humidity is lower by 2% than the set humidity the unit will stop the compressor and work for 3 minutes in fan only. When humidity is higher by 2% than selected humidity the compressor will start working after a 3 minutes delay. There is humidity measurement tolerance.

Laundry Mode:

For CD20L press  to automatically set the dehumidifier in laundry mode. Fan is set to high on laundry mode

For CD10L set the humidity to **CO** to operate continuously with maximum water extraction until the tank is full. Alternatively you can set the humidity level to 35%-40%RH. <40% is very dry and the unit will work until water tank is full as 35%RH is hardly achievable in UK domestic environment. Do not place clothes directly over any of the dehumidifier vents. Make sure that there is nothing blocking the hot air exhaust air flow and for best results place the laundry within 1.5 meters of the dehumidifier.

Note that if permanent drainage pipe is fitted the unit will not stop operation. Humidity set to achieve room humidity of around 35% is good for quick drying boost on initial run or emergencies, laundry mode. Not recommended for long normal operation in domestic/ office environment.

For allowing more moisture in the air, press the humidity control key and set to a higher percent value (e.g. 60-70%).

Humidity set to 50-55% RH; recommended setting, great for domestic operation and dry storage

Humidity set to 60% RH; great for personal comfort and applications where 50% RH is considered too dry

Humidity set to 70% RH; ideal for unoccupied properties or where economical run is needed without the need to go drier than 70% RH

Other features and Indicators

Tank Full Light

Red light will be on and the unit will beep when the tank is ready to be emptied, or when the tank is removed or not replaced in the proper position. The water level control switch shuts off the dehumidifier when the tank is full, or when the tank is removed or not replaced in the proper position. Empty and replace to resume operation.

Auto Defrost

When frost builds up on the evaporator coils, the compressor will cycle off and the unit will go in to defrost mode

When the unit is running in a room with temperature between 5°C and 12°C, it enters the defrost mode about once every 30 minutes.

When the unit is running in a room with temperature between 12°C and 20°C, it enters the defrost mode about once every 45 minutes.

Normal operation will resume after defrost mode.

Humidistat control and fan/ compressor operation

When the selected humidity is 2% lower than the user selected humidistat setting; the dehumidifier's compressor will be shut off automatically but the fan will still move to ensure air is not stale in the room. The unit will use only a minimal amount of energy in fan mode.

When the humidity is equal or higher than user selected humidity the compressor will restart once the 3 minutes delay compressor protection expires.

Power

After the unit has stopped, it is not recommended to resume operation for at least 10 minutes. This is to protect the compressor. Operation can resume after this period lapses. When the unit is restarted there is a 3 minutes delay before compressor will start.

Lightweight Portable Design

The dehumidifier is built to be compact and lightweight.

Your CD10L/CD20L dehumidifier is an advanced micro-CPU controlled device able of self-diagnostics. The LED display may also show the error and protections codes.

Positioning the dehumidifier

A badly positioned dehumidifier will have little effect. In positioning the dehumidifier please ensure circulation of air is not restricted around the unit.

Allow at least 20 cm space around the unit.

This dehumidifier is designed only for indoor residential / small office applications and any commercial or industrial use will invalidate the warranty.

Use in an enclosed area for maximum efficiency. Close all doors, windows to create an effective operating environment. Do not use outdoors.

Your electriQ dehumidifier will begin to protect your space from the harmful effects of excessive moisture as soon as it is turned on. Excess moisture is dispersed throughout your home. For this reason, the dehumidifier should be positioned in a central and clear location so that it can draw this moist air towards it from all over the home. A warm hallway or landing is an excellent position for your dehumidifier. If possible, leave interior doors ajar to allow air circulation.

Alternatively, if you have a serious problem in one area you can begin by positioning the dehumidifier there and moving it to a more central location at a later date. For the most effective use, run your dehumidifier with external doors and windows kept closed. Please note the unit should not be placed directly against a radiator or other heat source.

When positioning your electriQ dehumidifier, ensure that it is placed clear of any obstacle that may limit the air movement. Place the dehumidifier on a flat dry surface.

Note: Do not force castors to move over carpet or uneven surfaces, nor move the unit with water in the tank as it may tip over and spill water.

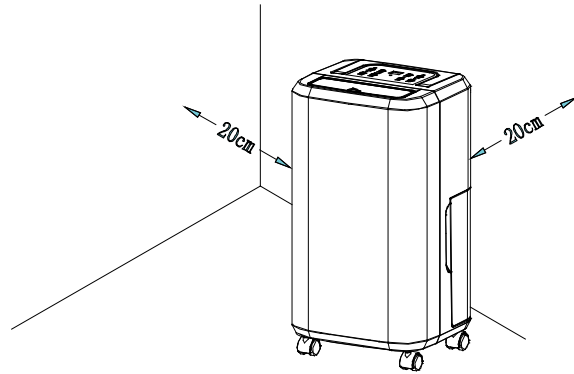

Water Drainage

When the water tank is full, the unit will stop automatically. When this happens the **tank full** red light will show on the control panel.

Note: Only empty the water tank when is full or before moving or storing the unit.

There are two ways to dispense collected water.

1. Use the tank.

When the tank is full, the unit will automatically stop running, the unit will beep and the tank full indicator light will flash. Slowly pull out the tank using both hands. Grip tank securely, and carefully pull out. Carry the tank by its handle, discard the water and reinsert the tanks into the dehumidifier. The tank must be in place and securely seated for the dehumidifier to operate again. The dehumidifier will re-start when the tank is restored in its correct position.

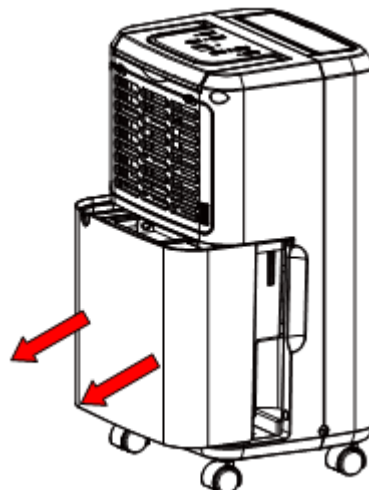

NOTES:

When you remove the bucket, do not touch sensors or any parts which are situated behind tank. Doing so may damage the product. Be sure to push the tank gently all the way into the unit. Banging the bucket against anything or failing to push it in securely into place may cause the unit not to operate.

Do not remove any parts from the water tank or tank enclosure. The water full sensor will no longer be able to detect the water level correctly and water may leak from the water tank.

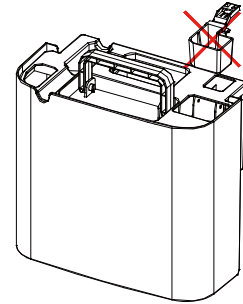

2. Continuous draining

Water can be automatically plumbed in or drained into a sink, a larger recipient or through the wall into an outside drain by attaching a pipe to the unit (10 mm internal diameter) (not included). Insert the pipe into the drain outlet at the back of the unit as shown here.

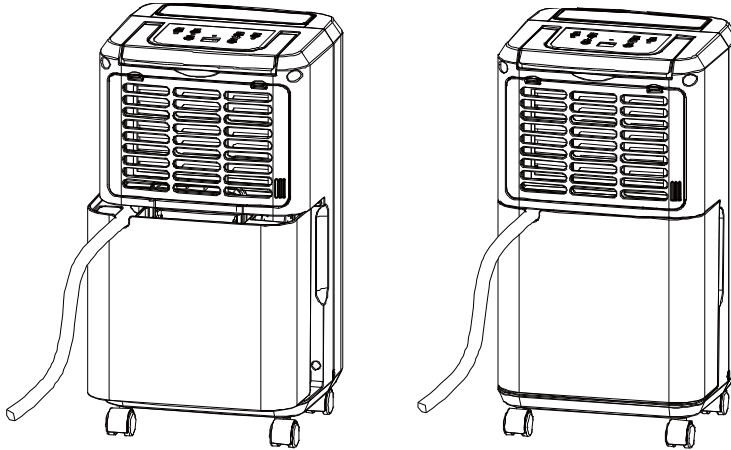

Make sure the connection between pipe and the drain outlet is tight and does not leak. Then direct the pipe to a suitable drainage point. This unit uses gravity fall to dispose water hence the drain should be lower than the unit water outlet. Put the tank back. Be sure to run the water pipe downward and let the water to flow out smoothly. Do not kink or bend the pipe.

NOTE: When the continuous drain feature is not being used, remove the drain hose from the outlet and place back the rubber bung.

The permanent drain can be used in conjunction with water pump (e.g. when draining a cellar) to lift the water upwards.

Care and Maintenance

Always shut off the unit and unplug from the mains before cleaning or performing any maintenance. When it is not in use for long periods it is advisable to remove the plug from the power socket. Do not use chemical solvents (such as benzene, alcohol or gasoline) as they may cause irreversible damage to the unit.

1. Clean the Grille and Case

Use water and a mild detergent to clean the washable antibacterial mesh filters. Do not use bleach or abrasives. Do not splash water directly onto the main unit. Doing so may cause an electrical shock and can lead to the insulation to deteriorate, or cause the unit to rust. The air intake and outlet grilles get soiled easily, so use a vacuum attachment or soft brush to clean. Wipe the dehumidifier body with a soft damp cloth or kitchen towel.

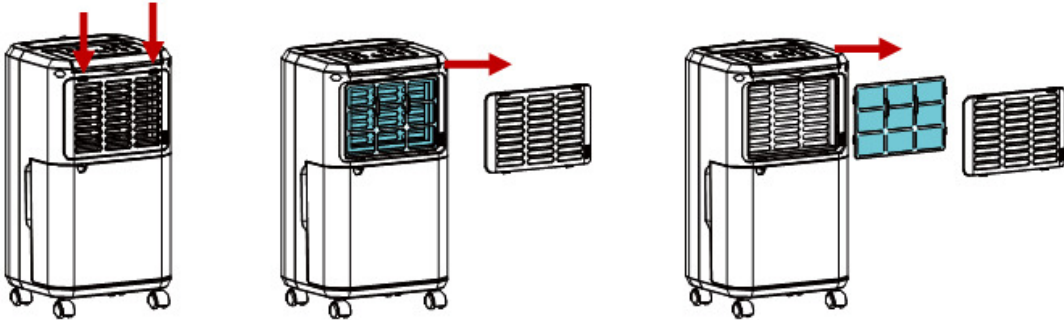

Remove the ABS frame and pull out the filters from the frame. Hoover gently the optional carbon once every 2-3 weeks approximately.

If the mesh filter is dirty hoover it, if it is heavily soiled wash it with warm soapy water and dry thoroughly before reinserting it in the unit.

When filter cleaning is finished and filters are dry placed them back into the filter frame and reassemble the unit.

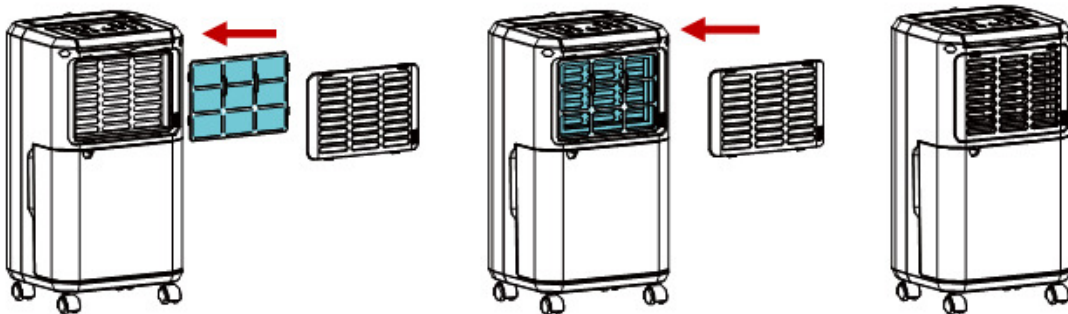

NOTE: Never run the unit without the mesh filter frame being assembled back.

2. Clean the water tank

Every few weeks, clean the tank to prevent growth of mould, mildew and bacteria. Partially fill the tank with clean water and add a little mild detergent. Swish it around and then empty the tank and rinse. **NOTE:** Do not use a dishwasher to clean the tank. After cleaning and drying the tank must be reinserted securely into dehumidifier in order to restart operation.

End of Season Maintenance:

1. Empty and clean the water tank.
2. Clean the unit and the filters as per cleaning procedure above.
3. Coil the power cord at the back of the unit
4. Cover the unit and keep it in a dry place.

Frequently Asked Questions

Why doesn't the dehumidifier seem to extract much water if the temperature is low?

This is a compressor dehumidifier which works best in temperatures above 15°C. If the temperature is low and the air is dryer than the setting on the humidistat the unit will not extract water. If you want to use a dehumidifier for outside buildings, unheated properties, boats or garages please check our desiccant range.

Why doesn't the unit work /or stops suddenly?

The water tank may be full or displaced. To rectify: empty the tank and carefully place the tank back in the unit. Also the unit may be running in dehumidifying mode with a low room temperature. Please check if the room temperature is lower than 5°C. If so, the unit will stop working while in dehumidifying mode. (unit may be defrosting).

The ambient operating range is between 5°C and 35°C with a relative humidity ranging from 30% to 80%. For maximum efficiency use the unit between 15°C and 32°C.

Sometimes cold and/or hot air comes out from the air outlet grill, why?

When the unit is in dehumidifying mode it absorbs humid air from room and freezes it to reduce the humidity.

During the cold cycle there should be cold air coming out of the unit

During the hot cycle hot dry air should be coming out of the outlet grill.

Troubleshooting

| Issue | Cause | Solution |
|---|---|---|
| Hot or cold air being produced | Normal Operation | When the unit is in dehumidifying mode it absorbs humid air from room and freezes it to reduce the humidity. During the cold cycle there should be cold air coming out of the unit During the defrost cycle hot dry air should be coming out of the outlet grill. |
| Unit does not operate | Is the plug properly inserted in the socket? | Insert the plug into the socket and turn the switch on. |
| | Does the tank full indicator is red? | Tank full, float displaced or tank not properly inserted. Empty tank, check float and make sure tank is properly inserted in unit. |
| Front louvres do not open | Louvre motor is blocked | Check if anything is blocking the louvre Try to move gently the louvres up and down while the unit is off If the above fails return the unit to service centre |
| Dehumidifier does not extract water | Is the unit set to a humidity level lower than the one in the room? | Set the humidity level on the humidistat below current humidity reading. |
| | Is the temperature too low for water extraction to be efficient? | Increase temperature in the room or reposition the unit. |
| | Is any intake grill or discharge blocked? Is the unit too close to walls. | Remove obstructions and restart the unit. Ensure a distance of at least 20 [cm between the unit & walls |
| Airflow seems weak | Is filter dirty or clogged? | Please service the filters regularly as per user manual. |
| Unit is noisy during operation | Is the unit on uneven surface? | Please place on flat horizontal surface. |
| | Is filter clogged? | Please service the filters regularly as per user manual. |
| E1 | Temperature sensor error | Use the unit within the prescribed temperature range. Unplug the unit, rest and plug it back in. If error repeats, call for service centre. |
| Defrost light on and unit stops regularly | Unit is defrosting | Allow the unit to automatically defrost. The protection will clear after the unit self defrosts. Increase temperature in the room if this repeats too often |
| Tank full red light | Water tank full notification | Tank is full or is not in the right position-- Empty the tank and replace in the right position. |
| Any other malfunctions will need to be reported to ElectrIQ service centre. Do not attempt unauthorised repairs as these may invalidate the warranty. | | |

Technical data

| Model | CD10L | CD20L |
|---|----------------------------------|----------------------------------|
| Voltage | 220-240V ~ 50Hz | 220-240V ~ 50Hz |
| Dehumidifying capacity | 10 L / day (at 30° C / 80%RH) | 20 L / day (at 30° C / 80%RH) |
| Fan Speeds | 1 | 2 |
| Power Consumption | 240 W | 380 W |
| Rated Current | 1.2 Amps | 2 Amps |
| Tank Capacity | 2 litres | 5 litres |
| Humidity settings range | 30%~90% | 30%~90% |
| Refrigerant | R134a, 65 grams | R134a, 250 grams |
| Airflow m3/h | 150 | 150 / 200 (Low/ High) |
| High / Low Pressure | 2.6 / 1.0 MPa | 2.6 / 1.0 MPa |
| Max noise level dB(A) | ≤42 | ≤47 |
| Power cord length | 1.8 meters | 1.8 meters |
| Dimensions mm (WxDxH) | 276x185x480 | 276x235x500 |
| Weight kgs (net/ gross) | 9.5 / 10.2 | 13.6 / 14.5 |
| All information provided is for reference only. Products specifications may change due to continuous product development. | | |

Disposal: Do not dispose this product as unsorted waste. Collection of such waste must be handled separately as special treatment is necessary.

Recycling facilities are now available for all customers at which you can deposit your old electrical products. Customers will be able to take any old electrical equipment to participating sites run by their local councils. Please remember that this equipment will be further handled during the recycling process, so please be considerate when depositing your equipment. Please contact the local council for details of your local household waste recycling centres.



ElectrIQ UK SUPPORT

www.ElectrIQ.co.uk/support

Please, for your own convenience, make these simple checks before calling the service line.

1. Has the unit been standing upright for at least 2 hours?
2. Is the unit plugged into the mains?
3. Is the fuse OK?
4. Switch the unit off and wait three minutes to see if the issue is resolved. Restart the unit.
5. Check if the water tank is full. Is the tank correctly inserted back into the unit?
6. Was the troubleshooting guide followed?

If the unit still fails to operate call: 0871 620 1057 or complete the online form

Office hours: 9AM - 5PM Monday to Friday

www.ElectrIQ.co.uk

Unit 2, The Nursery

Berristow Lane

South Normanton

Derbyshire, DE55 2FX